

2021

# contract



**Siesta**  
exclusive



## Siesta exclusive

Siesta, established in 1987, offers to an international public satisfying the most varied needs, through products conceived in the name of functionality and design.

The continuous attention to the needs and tendencies of the market has led to a constant and balanced development throughout time, determining a first hand position for both productive capacity and also from a commercial point of view. This has been possible thanks to constant research on productive and technological aspects and also on the esthetics and on product promotion.

The freshness of the design of Siesta tables and chairs together with the competitive price satisfies different levels of needs. These characteristics give Siesta access to different market sectors, for example contract and domestic.

The collection includes chairs, bar stools and tables, all designed to be multifunctional and multi-purpose, user friendly and with an indisputable style. With their colour, sense of irony, play on senses and unique forms, Siesta products are immediately recognizable throughout the world, offering longlasting, practical enjoyment. Today Siesta exports 75% of its production to 80 countries around the globe through its comprehensive network of agents and dealers.

Siesta offers an extremely wide range of indoor and outdoor products, with innumerable colour variations, with plastic materials like polypropylene and fiberglass matched to wood or metal or latest trend like transparent polycarbonate or glossy PA6 nylon, with strong technical characteristics, that give the product inimitable qualities such as softness, opaqueness, flexibility and resistance to atmospheric agents.

A concentrate of quality that makes the Siesta product so unique and special.



# CHECKLIST OF OBJECTS

CHAIRS & ARMCHAIRS ▶					
	SKY 6	SKY LOUNGE 8	PACIFIC ARMCHAIR 10	SLIM ARMCHAIR 12	MARIE 14
					
DREAM 28	MONNA 30	LISA 32	LUCY 34	LOFT 36	MILA 38
					
BLOOM 52	AIR XL 54	AIR 56	MIRANDA 58	SOHO 60	JOSEPHINE 62
					
ELIZABETH-C 76	ARTHUR 78	BO 80	BEE 82	MISS BIBI 84	MR BOBO 86
					
DIVA 100	BOX 102	BOX SOFA 104	ARES 106	ARTEMIS 108	ARTEMIS XL 110
			LOUNGE ▶ 		
ROMEO 124	JULIETTE 126	GALA/BELLA 128			

					
VICTOR 16	VICTOR XL 18	CROSS 20	CROSS XL 22	MARCEL 24	MARCEL XL 26
					
PIA 40	SUNSET 42	PLUS 44	SNOW 46	MOON 48	FLASH 50
					
NAPOLEON 64	OPERA 66	CHIAVARI 68	CRYSTAL 70	ELIZABETH 72	BABY ELIZABETH 74
					
CARMEN 88	ALLEGRA 90	ALLEGRA-PP 92	MIO-PP 94	MIO 96	MAYA 98
					
TIFFANY 112	TIFFANY-S 114	LUCCA 116	LUCCA-T 118	DOLCE 120	VITA 122
					
MYKONOS LOUNGE SET 136		MYKONOS LOUNGE CORNER SET 140		MYKONOS LOUNGE ARMCHAIR 144	MYKONOS LOUNGE TABLE 146

# CHECKLIST OF OBJECTS

		SUNLOUNGER ▶			
MYKONOS LOUNGE TABLE XL 148	MYKONOS EXTENSION PART 150			SLIM 152	PACIFIC 154
					
MARCEL BAR 75 164	MARCEL BAR 65 166	MAYA BAR 75 168	MAYA BAR 65 170	ARES BAR 75 172	OPERA BAR 75/65 174
					TABLES ▶
SKY SIDE TABLE 196	SKY LOUNGE TABLE 198	BOX TABLE 200	OCEAN SIDE TABLE 202	OCEAN TABLE 204	
					
AIR TABLE 80 218	AIR TABLE 140 220	AIR TABLE 180 222	SKY FOLDING LEGS 224	SKY LEGS 226	AIR LEGS SMALL 228
					
ARES 140 238	MAYA 80 240	MAYA 120 240	MAYA 140 240	ICE 246	ICE 246
LIGHTING ▶				LINKING ▶	
	DODO 264	NOVA 266	SMART 268		LINK LINKING DEVICE 270

STOOLS & COMPLEMENTS ▶					
		VICTOR BAR 75 156	VICTOR BAR 65 158	CROSS BAR 75 160	CROSS BAR 65 162
					
CHIAVARI BAR 75/65 178	FOX 75/65 182	AIR BAR 75/65 186	ARIA 190	GIO 75 192	QUEEN 194
					
VEGAS TABLE 206	VEGAS TABLE MEDIUM 208	VEGAS TABLE XL 210	SKY FOLDING TABLE 60 212	SKY TABLE 70 214	SKY TABLE 80 216
					
AIR LEGS MEDIUM 228	AIR LEGS XL 228	OCTOPUS 60 230	OCTOPUS BAR 232	SKY FOLDING BAR TABLE 60 234	ARES 80 236
					
ICE LEG&BASE 250	MANGO 252	MANGO ALU 254	FORZA 256	SORTIE 258	POPPY/ ELFO 260
CUSHIONS ▶				Siesta exclusive	
	ARTEMIS XL CUSHIONS 272	MYKONOS CUSHIONS 274	SLIM CUSHIONS 276	siesta.com.tr	



Sky armchair is produced with recyclable polypropylene seat and legs reinforced with glass fiber. For indoor and outdoor use. Can be disassembled.

102 Sky

CATAS  
TEST REPORT  
261210

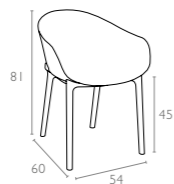

Colors



White Black Dark Grey Taupe Red



Yellow



# Sky Lounge



Sky lounge chair is produced with recyclable polypropylene seat and legs reinforced with glass fiber. For indoor and outdoor use. Can be disassembled. The SKY collection also includes a coffee table, designed to match the styling silhouette of the chair to perfection.

103 Sky Lounge

CATAS  
TEST REPORT  
257287

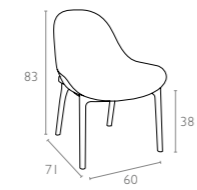

### Colors

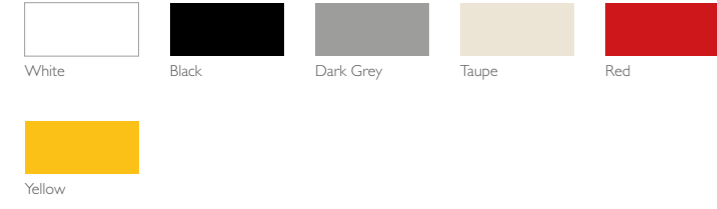

## Pacific Armchair



Pacific armchair with Batyline fabric from Serge Ferrari is made from a weather-proof, UV-protected resin reinforced by glass fiber that stands up to summer showers and strong sun, making it the ideal, worry-free addition to your outdoor seating area. This versatile armchair pairs perfectly with the Pacific sunlounger, as well as a wide range of other outdoor tables. For domestic or commercial use.

## 023 Pacific Armchair

CATAS  
TEST REPORT

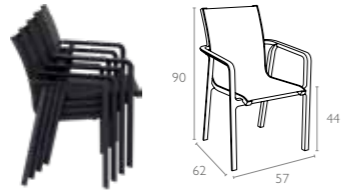

**Serge Ferrari**

Colors



White / White

Black / Black

Taupe / Taupe

Dark Grey / Black



# Slim Armchair



Slim armchair is made from a weather-proof, UV-protected resin reinforced by glass fiber that stands up to summer showers and strong sun, making it the ideal, worry-free addition to your outdoor seating area. This versatile armchair pairs perfectly with the Slim sunlounger, as well as a wide range of other outdoor tables. For domestic or commercial use.

013 Slim Armchair

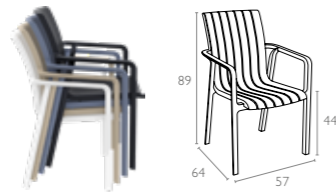

### Colors



White

Black

Dark Grey

Taupe





# Marie



Marie stacking chair is produced with a single injection of polypropylene reinforced with glass fiber obtained by means of the latest generation of air moulding technology with neutral tones. For indoor and outdoor use.

## 251 Marie

CATAS  
TEST REPORT  
294904



### Colors



White

Black

Olive Green





Victor stacking chair is produced with a single injection of polypropylene reinforced with glass fiber obtained by means of the latest generation of air moulding technology with neutral tones. For indoor and outdoor use.

## 252 Victor

CATAS  
TEST REPORT  
294905

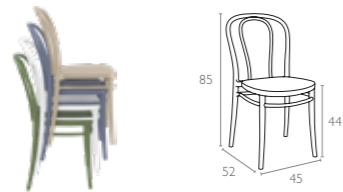

## Colors



White

Black

Dark Grey

Taupe

Olive Green



# Victor XL



Victor XL stacking armchair is produced with a single injection of polypropylene reinforced with glass fiber obtained by means of the latest generation of air moulding technology with neutral tones. For indoor and outdoor use.

253 Victor XL

CATAS  
TEST REPORT  
294886

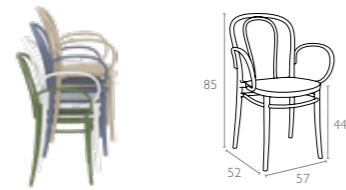

Colors



White    Black    Dark Grey    Taupe    Olive Green





Cross stacking chair is produced with a single injection of polypropylene reinforced with glass fiber obtained by means of the latest generation of air moulding technology with neutral tones. For indoor and outdoor use.

## 254 Cross

CATAS  
TEST REPORT  
294906

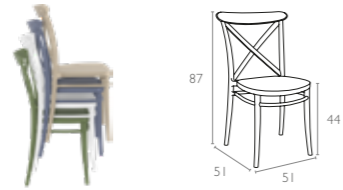

## Colors



White

Black

Dark Grey

Taupe

Olive Green



# Cross XL



Cross XL stacking armchair is produced with a single injection of polypropylene reinforced with glass fiber obtained by means of the latest generation of air moulding technology with neutral tones. For indoor and outdoor use.

## 256 Cross XL

CATAS  
TEST REPORT  
294885



### Colors





Marcel stacking chair is produced with a single injection of polypropylene reinforced with glass fiber obtained by means of the latest generation of air moulding technology with neutral tones. For indoor and outdoor use.

#### 257 Marcel

CATAS  
TEST REPORT  
294903

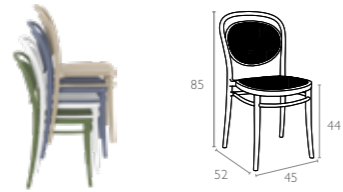

#### Colors



White

Black

Dark Grey

Taupe

Olive Green



## Marcel XL



Marcel XL stacking armchair is produced with a single injection of polypropylene reinforced with glass fiber obtained by means of the latest generation of air moulding technology with neutral tones. For indoor and outdoor use.

## 258 Marcel XL

CATAS  
TEST REPORT  
294887

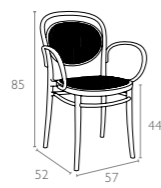

## Colors



White



Black



Dark Grey

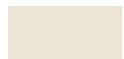

Taupe



Olive Green





Dream folding chair is produced with a single injection of polypropylene reinforced with glass fiber obtained by means of the latest generation of air moulding technology with neutral tones. For indoor and outdoor use.

## 079 Dream

CATAS  
TEST REPORT  
294880

designed by  
Frédéric Boonen  
**bds**

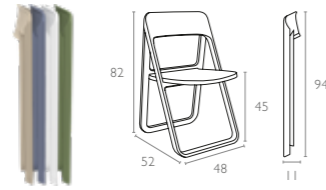

## Colors



White

Black

Dark Grey

Taupe

Red



Olive Green







Monna chair is produced with a single injection of polypropylene reinforced with glass fiber obtained by means of the latest generation of air moulding technology with neutral tones. For indoor and outdoor use.

127 Monna

CATAS  
TEST REPORT  
276554

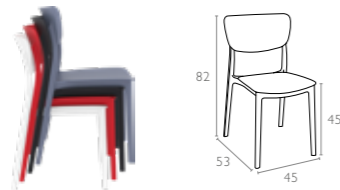

Colors



White Black Dark Grey Taupe Red



Olive Green





Lisa armchair is produced with a single injection of polypropylene reinforced with glass fiber obtained by means of the latest generation of air moulding technology with neutral tones. For indoor and outdoor use.

126 Lisa

CATAS  
TEST REPORT  
276570

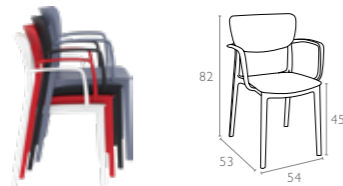

Colors





Lucy chair is produced with a single injection of polypropylene reinforced with glass fiber obtained by means of the latest generation of air moulding technology with neutral tones. For indoor and outdoor use.

129 Lucy

CATAS  
TEST REPORT  
276562



Colors



White

Black

Dark Grey

Taupe

Olive Green





Loft armchair is produced with a single injection of polypropylene reinforced with glass fiber obtained by means of the latest generation of air moulding technology with neutral tones. For indoor and outdoor use.

### 128 Loft

**CATAS**  
TEST REPORT  
276563

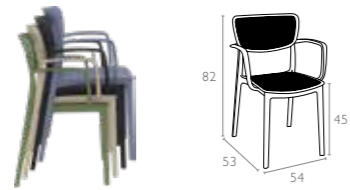

### Colors





Mila armchair is produced with a single injection of polypropylene reinforced with glass fiber obtained by means of the latest generation of air moulding technology with neutral tones. For indoor and outdoor use.



085 Mila

CATAS  
TEST REPORT  
233341



Colors



White

Black

Dark Grey

Taupe

Red



Yellow





Pia chair is produced with a single injection of polypropylene reinforced with glass fiber obtained by means of the latest generation of air moulding technology with neutral tones. For indoor and outdoor use.



086 Pia

CATAS  
TEST REPORT  
233342

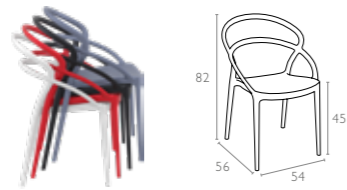

Colors



White

Black

Dark Grey

Taupe

Red



Yellow





Sunset chair is produced with a single injection of polypropylene reinforced with glass fiber obtained by means of the latest generation of air moulding technology with neutral tones. For indoor and outdoor use.



088 Sunset

CATAS  
TEST REPORT  
233343

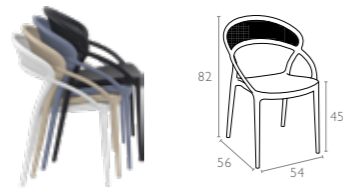

Colors



White

Black

Dark Grey

Brown

Taupe





Plus armchair is produced with a single injection of polypropylene reinforced with glass fiber obtained by means of the latest generation of air moulding technology with neutral tones. For indoor and outdoor use.

093 Plus

CATAS  
TEST REPORT  
235829

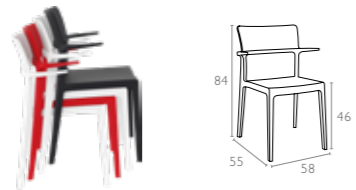

Colors



White

Black

Red







Snow chair is produced with a single injection of polypropylene reinforced with glass fiber obtained by means of the latest generation of air moulding technology with neutral tones. For indoor and outdoor use.

092 Snow

CATAS  
TEST REPORT  
235827

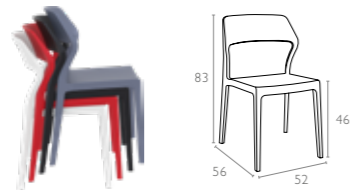

Colors



White Black Dark Grey Taupe Red



Yellow Olive Green





Stacking chair with the latest generation of air moulding thermoplastic injection. Seat in polypropylene reinforced with glass fiber, backrest in transparent polycarbonate. For indoor and outdoor use.

090 Moon

CATAS  
TEST REPORT  
235828

Made with  
**Makrolon**<sup>®</sup>  
The high-tech polycarbonate

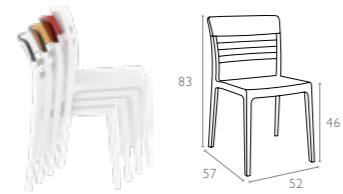

Colors

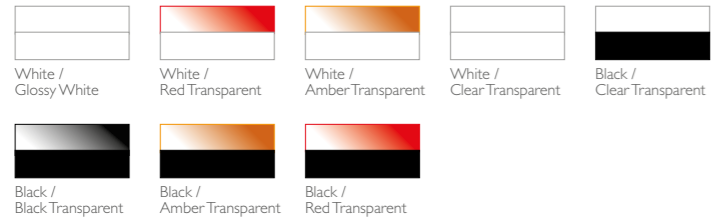



Stacking chair with the latest generation of air moulding thermoplastic injection. Seat in polypropylene reinforced with glass fiber, backrest in transparent polycarbonate. For indoor and outdoor use.

## 091 Flash

CATAS  
TEST REPORT  
235828

Made with  
**Makrolon®**  
The high-tech polycarbonate

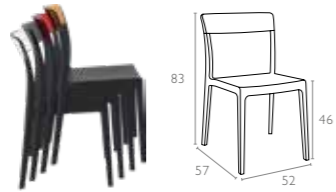

## Colors

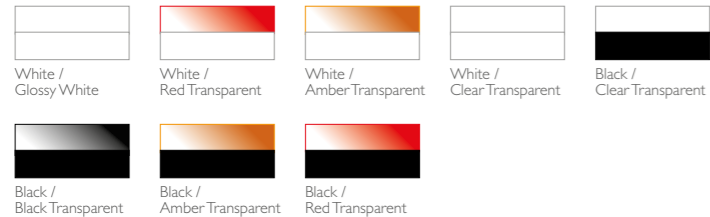

# Bloom



Bloom chair is produced with a single injection of polypropylene reinforced with glass fiber obtained by means of the latest generation of air moulding technology with neutral tones. For indoor and outdoor use.

## 048 Bloom

CATAS  
TEST REPORT  
207974

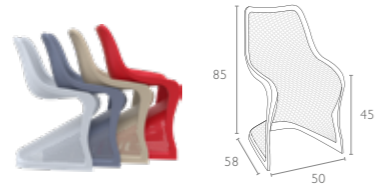

### Colors

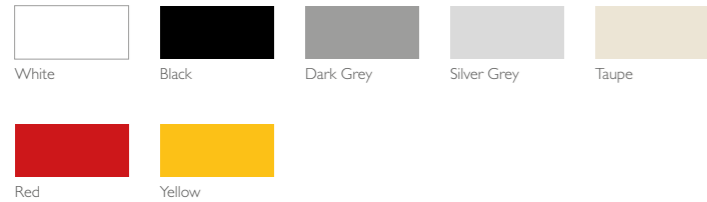



Air XL armchair is produced with a single injection of polypropylene reinforced with glass fiber obtained by means of the latest generation of air moulding technology with neutral tones. For indoor and outdoor use.

007 Air XL

CATAS  
TEST REPORT  
182331

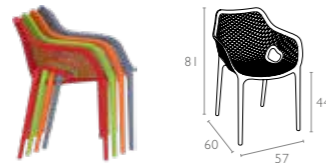

Colors





Air chair is produced with a single injection of polypropylene reinforced with glass fiber obtained by means of the latest generation of air moulding technology with neutral tones. For indoor and outdoor use.

014 Air

CATAS  
TEST REPORT  
163635



Colors





Miranda chair is produced with a single injection of polypropylene reinforced with glass fiber obtained by means of the latest generation of air moulding technology with neutral tones. For indoor and outdoor use.

#### 039 Miranda

CATAS  
TEST REPORT  
201779



#### Colors





Soho chair is produced with a single injection of polypropylene reinforced with glass fiber obtained by means of the latest generation of air moulding technology with neutral tones. For indoor and outdoor use.

054 Soho

CATAS  
TEST REPORT  
201772



Colors



White

Black

Dark Grey

Brown

Taupe



Red







Josephine wedding chair is produced with a single injection of polypropylene reinforced with glass fiber obtained by means of the latest generation of air moulding technology with neutral tones. For indoor and outdoor use.

#### 050 Josephine

CATAS  
TEST REPORT  
201775

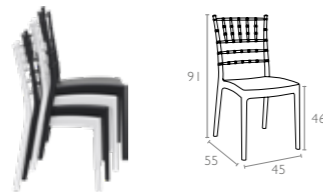

#### Colors



White



Black



## Napoleon



Napoleon wedding chair is produced with a single injection of polypropylene reinforced with glass fiber obtained by means of the latest generation of air moulding technology with neutral tones. For indoor and outdoor use.

## 044 Napoleon

CATAS  
TEST REPORT  
201775

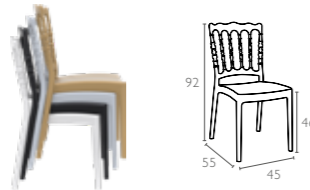

## Colors



White

Black

Silver Grey

Gold





Stacking wedding chair for indoor and outdoor use in clear or shiny polycarbonate. Scratch resistant, UV - resistant.

061 Opera

CATAS  
TEST REPORT  
226345

Made with  
**Makrolon®**  
The high-tech polycarbonate

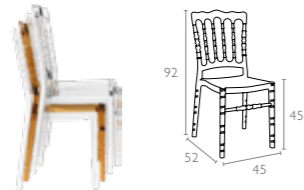

Colors



Glossy White

Amber Transparent

Clear Transparent

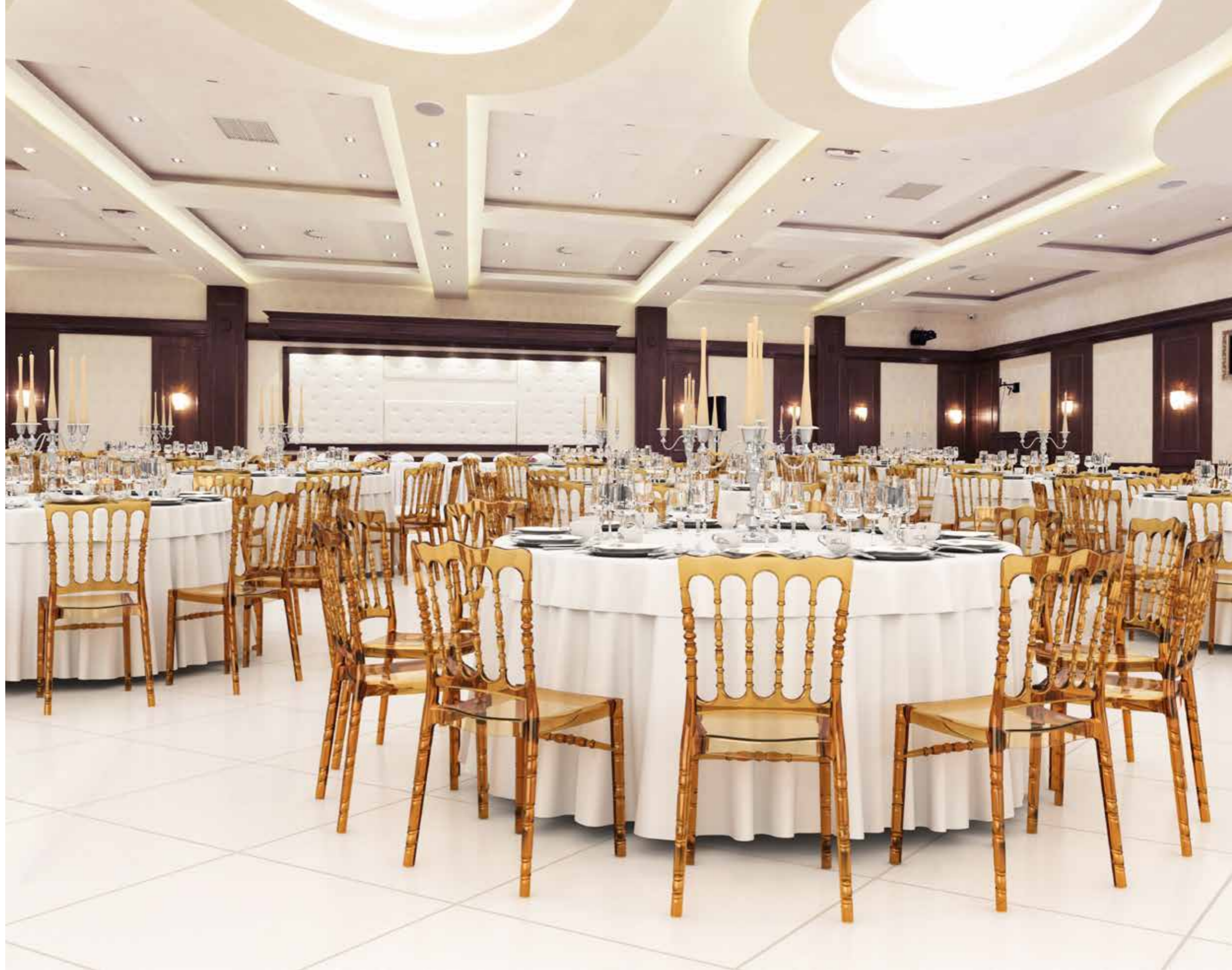

## Chiavari



Stacking wedding chair for indoor and outdoor use in clear or shiny polycarbonate. Scratch resistant, UV - resistant.

071 Chiavari

CATAS  
TEST REPORT  
226347

Made with  
**Makrolon®**  
The high-tech polycarbonate

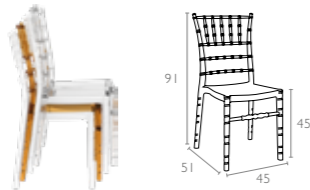

Colors



Glossy White

Amber Transparent

Clear Transparent





Stacking armchair for indoor and outdoor use in clear polycarbonate moulded with gas technology of the second generation. Scratch resistant, UV - resistant.

#### 052 Crystal

CATAS  
TEST REPORT  
108091

Made with  
**Makrolon®**  
The high-tech polycarbonate

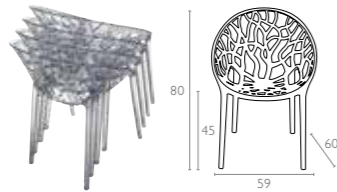

#### Colors

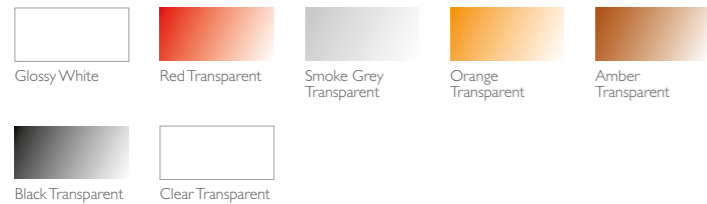



Stacking chair for indoor and outdoor use in shiny technopolymer PA6 nylon or clear polycarbonate. Scratch resistant, self-extinguishing classification V2, UV-resistant.

## 034 Elizabeth

CATAS  
TEST REPORT  
107368

Made with  
**Makrolon®**  
The high-tech polycarbonate

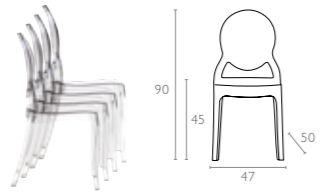

## Colors

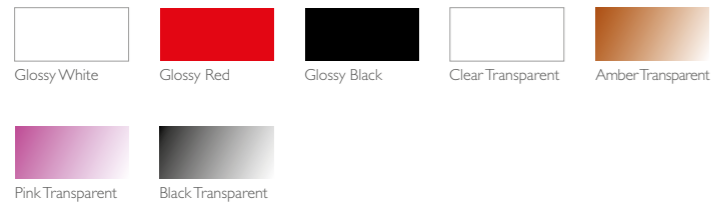

# Baby Elizabeth



Stacking children chair Baby Elizabeth for indoor and outdoor use in clear polycarbonate. Scratch resistant, UV – resistant.

051 Baby Elizabeth

CATAS  
TEST REPORT  
120253

Made with  
**Makrolon®**  
The high-tech polycarbonate

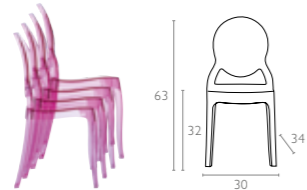

Colors

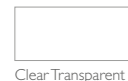

Clear Transparent





Stacking chair for indoor use with removable cushion on the seat, in shiny technopolymer PA6 nylon or clear polycarbonate.

034 Elizabeth-C

CATAS  
TEST REPORT  
107368

Made with  
**Makrolon®**  
The high-tech polycarbonate

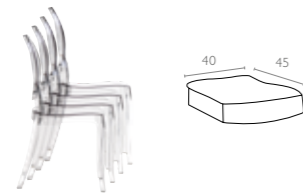

Cushion Colors

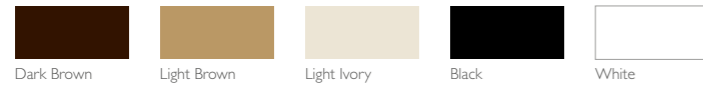

Dark Brown

Light Brown

Light Ivory

Black

White







Stacking armchair for indoor and outdoor use in shiny technopolymer PA6 nylon or clear polycarbonate. Scratch resistant, self-extinguishing classification V2, UV-resistant.

053 Arthur

CATAS  
TEST REPORT  
129749

Made with  
**Makrolon®**  
The high-tech polycarbonate

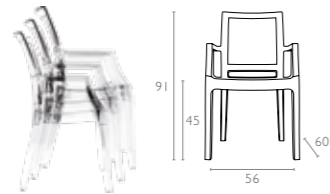

Colors



Glossy White Glossy Red Glossy Black Clear Transparent Amber Transparent



Black Transparent





Stacking chair for indoor and outdoor use in clear or shiny polycarbonate. Scratch resistant, UV - resistant.

005 Bo

CATAS  
TEST REPORT  
154712

Made with  
**Makrolon®**  
The high-tech polycarbonate

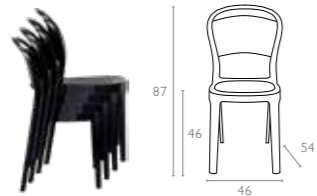

Colors

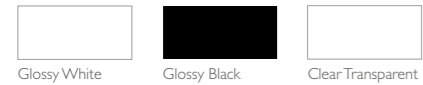

Glossy White

Glossy Black

Clear Transparent





Stacking chair for indoor and outdoor use in clear or shiny polycarbonate. Scratch resistant, UV - resistant.

Design By  
  
 ILANIT OVADYA

021 Bee

CATAS  
 TEST REPORT  
 154712

Made with  
 **Makrolon®**  
 The high-tech polycarbonate

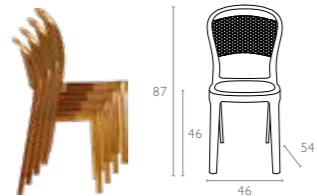

Colors



Glossy White Glossy Black Red Transparent Amber Transparent Black Transparent



Clear Transparent





Stacking chair with the latest generation of air moulding thermoplastic injection. Seat in polypropylene reinforced with glass fiber, backrest in transparent polycarbonate. For indoor and outdoor use.

## 055 Miss Bibi

CATAS  
TEST REPORT  
112744

Made with  
**Makrolon®**  
The high-tech polycarbonate



## Colors





Stacking chair with the latest generation of air moulding thermoplastic injection. Seat in polypropylene reinforced with glass fiber, backrest in transparent polycarbonate. For indoor and outdoor use.

056 Mr Bobo

CATAS  
TEST REPORT  
112744

Made with  
**Makrolon®**  
The high-tech polycarbonate



Colors

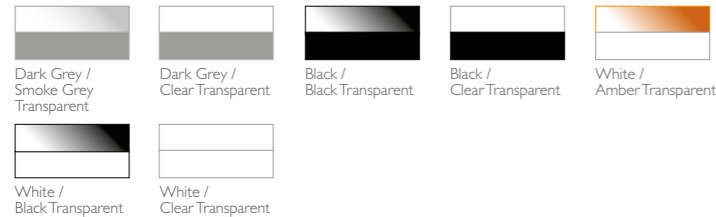



Stacking armchair with the latest generation of air moulding thermoplastic injection. Seat in polypropylene reinforced with glass fiber, backrest in transparent polycarbonate. For indoor and outdoor use.

## 059 Carmen

CATAS  
TEST REPORT  
120254

Made with  
**Makrolon®**  
The high-tech polycarbonate

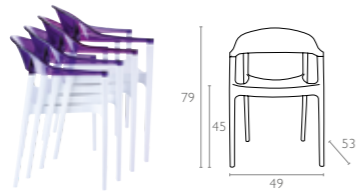

## Colors

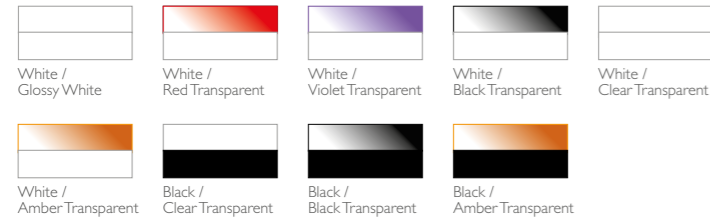

## Allegra



Recyclable polycarbonate main body. Legs frame in tubular chrome steel. Stackable. For indoor use.

057 Allegra

Made with  
**Makrolon®**  
The high-tech polycarbonate

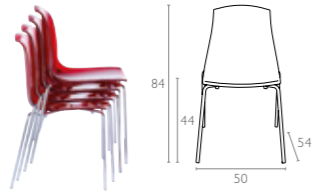

Colors



Glossy White Red Transparent Amber Transparent Black Transparent Clear Transparent





Recyclable polycarbonate main body. Legs frame in polypropylene.  
For indoor and outdoor use. Can be disassembled.

096 Allegra-PP

Made with  
**Makrolon®**  
The high-tech polycarbonate

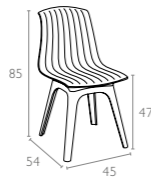

Colors



White /  
Glossy White

Black /  
Black Transparent

Brown /  
Glossy White







Mio-PP chair is produced with recyclable polypropylene seat and legs reinforced with glass fiber. For indoor and outdoor use. Can be disassembled.

094 Mio-PP

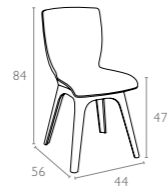

Colors



White / White

Black / Black

Brown / White





Stacking chair with recyclable polypropylene seat and backrest and painted steel legs. For indoor use.

046 Mio

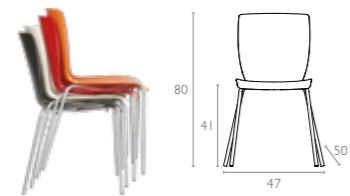

Colors



Black

Orange

Red

Beige

White





The latest generation air moulding process, as used for Maya, allows perfect control for the channel draining and the wall thickness. In designing Maya, the designers developed a formally characterized shape yet suitable for different ambiances - contemporary, classic, informal or elegant - where it easily settles in, thanks to a colour range including brights as well as neutral tones. For indoor and outdoor use.

#### 025 Maya

CATAS  
TEST REPORT  
73610

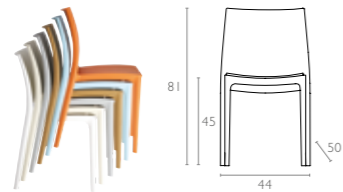

#### Colors

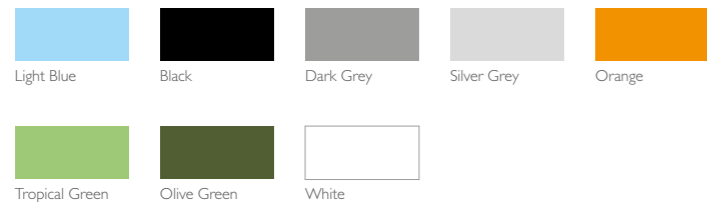



Diva armchair is produced with a single injection of polypropylene reinforced with glass fiber obtained by means of the latest generation of air moulding technology with neutral tones. For indoor and outdoor use.

### 028 Diva

CATAS  
TEST REPORT  
101128

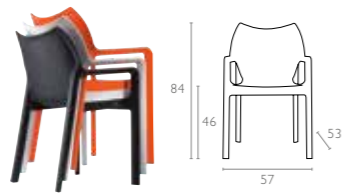

### Colors





Recyclable polypropylene stacking armchair, strong and stable.  
Suitable for outdoor contract use.

## 058 Box

CATAS  
TEST REPORT  
117039

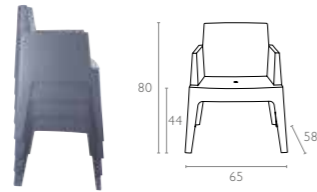

## Colors



## Box Sofa



Recyclable polypropylene stackable sofa, very sturdy and stable.  
Suitable for outdoor contract use.

## 063 Box Sofa

CATAS  
TEST REPORT  
152392

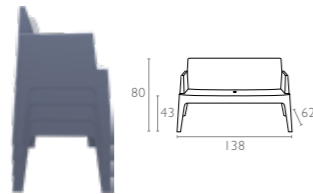

## Colors





Ares chair is produced with a single injection of polypropylene reinforced with glass fiber obtained by means of the latest generation of air moulding technology with neutral tones. For indoor and outdoor use.

## 009 Ares

CATAS  
TEST REPORT  
163637

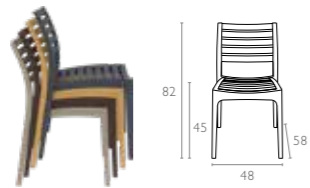

## Colors



White

Black

Dark Grey

Silver Grey

Brown

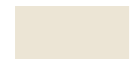

Taupe



Teak



# Artemis



Artemis armchair is produced with a single injection of polypropylene reinforced with glass fiber obtained by means of the latest generation of air moulding technology with neutral tones. For indoor and outdoor use.

## 011 Artemis

CATAS  
TEST REPORT  
163636

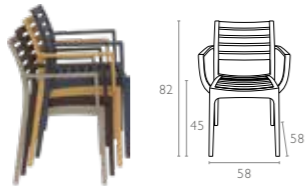

### Colors

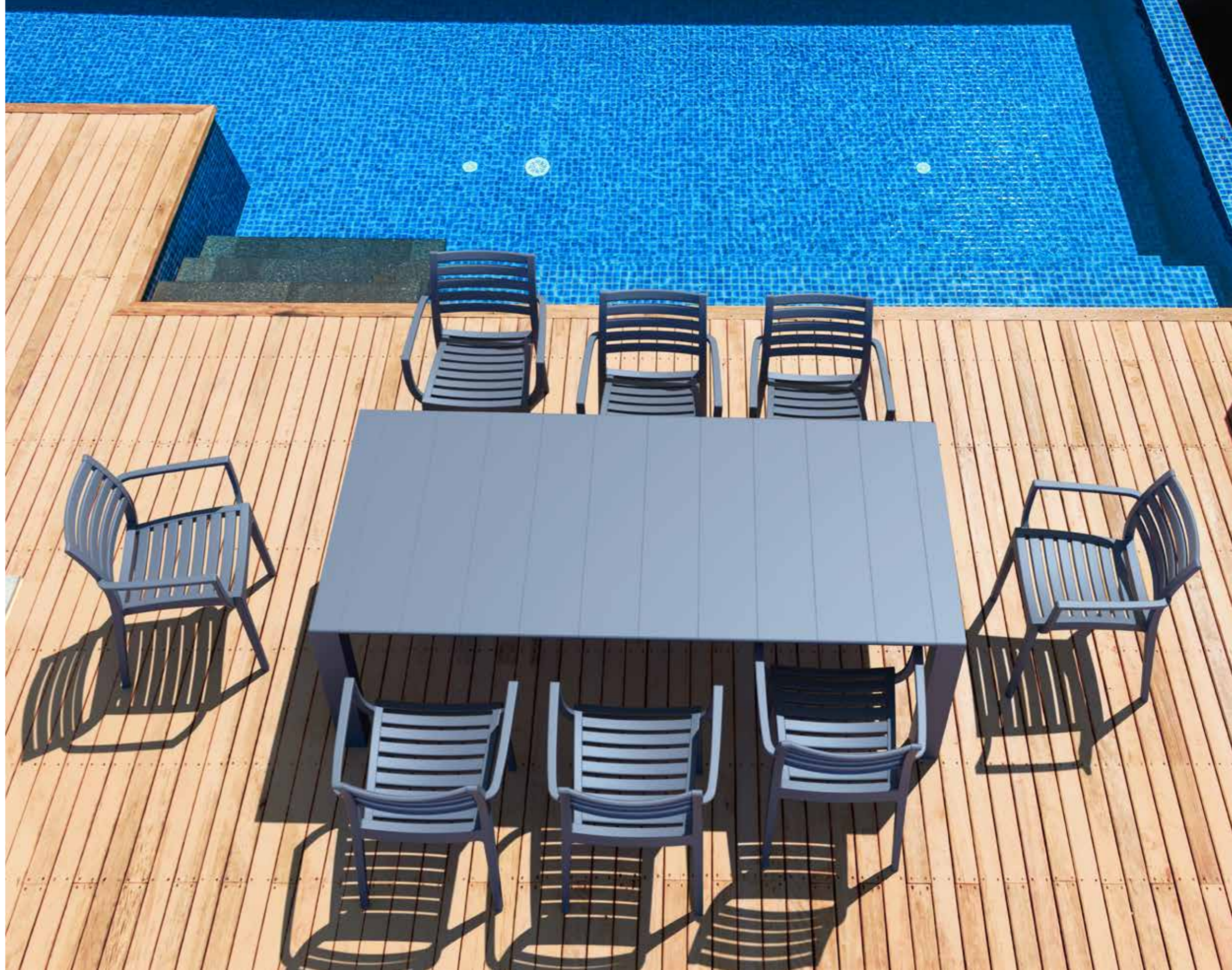
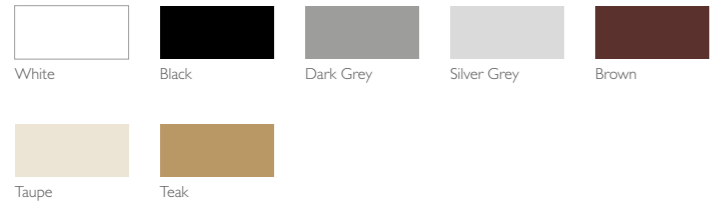



## Artemis XL



Artemis XL Lounge armchair is stackable and produced with a single injection of polypropylene reinforced with glass fiber, for indoor and outdoor use with or without cushion and non-slip feet. The Artemis collection also includes a coffee table, in various sizes, designed to match the styling silhouette of the chair to perfection.

## 004 Artemis XL

CATAS  
TEST REPORT  
184080

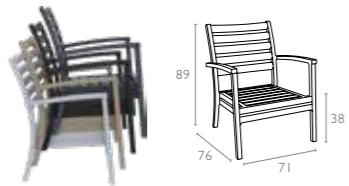

## Colors



Black

Dark Grey

Silver Grey

Taupe

White





Tiffany chair is produced with a single injection of polypropylene reinforced with glass fiber obtained by means of the latest generation of air moulding technology with neutral tones. Stackable. For indoor and outdoor use.

## 018 Tiffany

CATAS  
TEST REPORT  
135690

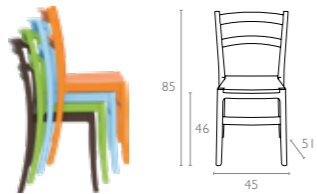

## Colors



## Tiffany-S



Tiffany-S chair is produced with a single injection of polypropylene reinforced with glass fiber obtained by means of the latest generation of air moulding technology with neutral tones. Stackable. For indoor and outdoor use.

019 Tiffany-S

CATAS  
TEST REPORT  
135690

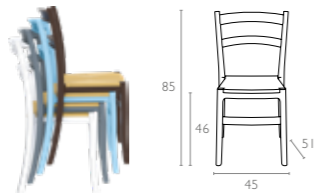

Colors



Brown

Dark Grey

Light Blue

White





Stacking chair with the latest generation of air moulding thermoplastic injection. For indoor and outdoor use.

026 Lucca

CATAS  
TEST REPORT  
85006

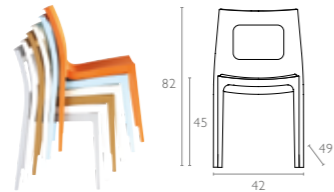

Colors



Light Blue

Dark Grey

Silver Grey

Orange

Tropical Green



White





Stacking chair with the latest generation of air moulding thermoplastic injection. Back in transparent polycarbonate.  
For indoor and outdoor use.

029 Lucca-T

Made with  
**Makrolon®**  
The high-tech polycarbonate

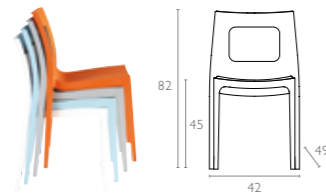

Colors



Light Blue

Orange

White





Stacking armchair with recyclable polypropylene seat and backrest and anodized aluminium legs. Diameter 25 mm. For indoor and outdoor use.

047 Dolce

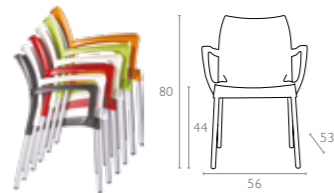

Colors



Black

Light Green

Orange

Red

Beige



Dark Grey



White





Stacking chair with recyclable polypropylene seat and backrest and anodized aluminium legs. Diameter 25 mm.  
For indoor and outdoor use.

## 049 Vita

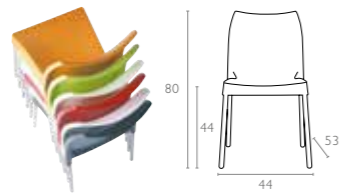

## Colors



Black    Light Green    Orange    Red    Beige



Dark Grey    White





Stacking armchair with recyclable polypropylene seat and backrest and anodized aluminium legs. Diameter 25 mm. For indoor and outdoor use.

## 043 Romeo



## Colors



Blue

Black

Light Green

Orange

Red



Beige



White







Stacking chair with recyclable polypropylene seat and backrest and anodized aluminium legs. Diameter 25 mm. For indoor and outdoor use.

#### 045 Juliette

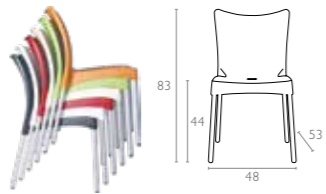

#### Colors



Blue

Black

Light Green

Orange

Red



Beige

White





Stacking armchair in anodized aluminium with seat and back in recyclable polypropylene with latest generation of air moulding thermoplastic injection. Diameter 25 mm. For indoor and outdoor use.

041 Gala

CATAS  
TEST REPORT  
79261

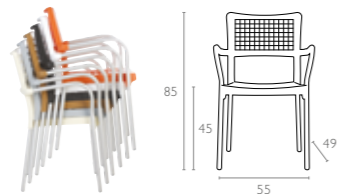

Colors



Teak

Orange

White





Stacking armchair in anodized aluminium with seat and back in recyclable polypropylene with latest generation of air moulding thermoplastic injection. Diameter 25 mm. For indoor and outdoor use.

040 Bella

CATAS  
TEST REPORT  
79261

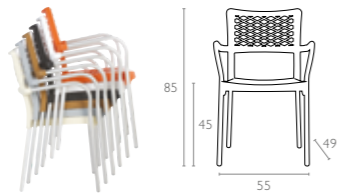

Colors



Teak

Orange

White



# Mykonos Lounge Set XL



Mykonos Lounge Set XL is designed for easy self assembly, it is made of durable weather-resistant resin reinforced with glass fiber. Non-metallic frame will never unravel, rust or decay. It is UV protected which insures the colors will not fade. Can be disassembled. For indoor and outdoor contract use.

Mykonos Lounge Armchair

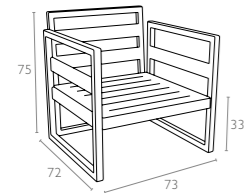

Mykonos Lounge Sofa XL

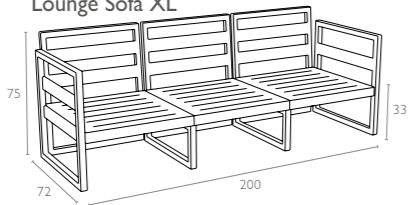

Mykonos Lounge Table XL

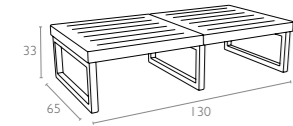

Mykonos Seat Cushion

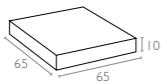

Mykonos Backrest Cushion

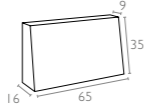

133 Mykonos Lounge Set XL

Colors



Cushions



CATAS  
TEST REPORT  
282198

etisilk  
Outdoor Furniture Fabrics





# Mykonos Lounge Set



Mykonos Lounge Set is designed for easy self assembly, it is made of durable weather-resistant resin reinforced with glass fiber. Non-metallic frame will never unravel, rust or decay. It is UV protected which insures the colors will not fade. Can be disassembled. For indoor and outdoor contract use.

Mykonos  
Lounge Armchair

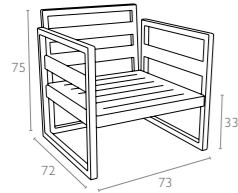

Mykonos  
Lounge Sofa

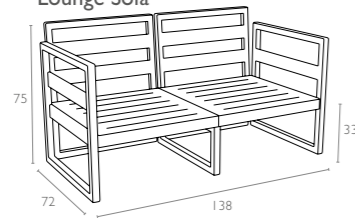

Mykonos  
Lounge Table

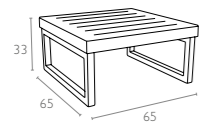

Mykonos  
Seat Cushion

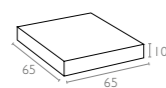

Mykonos  
Backrest Cushion

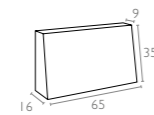

I 32 Mykonos Lounge Set

## Colors



White

Taupe

Silver Grey

## Cushions

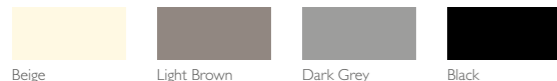

Beige

Light Brown

Dark Grey

Black

**etisilk**  
Outdoor Furniture Fabrics

**CATAS**  
TEST REPORT  
282198





# Mykonos Lounge Corner Set



Mykonos Lounge Corner Set is designed for easy self assembly, it is made of durable weather-resistant resin reinforced with glass fiber. Non-metallic frame will never unravel, rust or decay. It is UV protected which insures the colors will not fade. Can be disassembled. For indoor and outdoor contract use.

Mykonos Lounge Corner

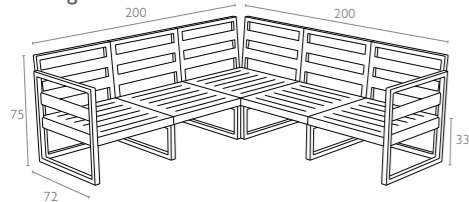

Mykonos Lounge Table

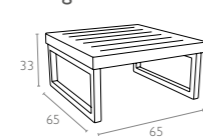

Mykonos Seat Cushion

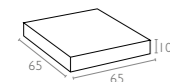

Mykonos Backrest Cushion

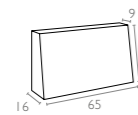

Mykonos Corner Cushion

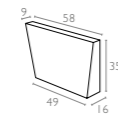

134 Mykonos Lounge Corner Set

Colors



Cushions

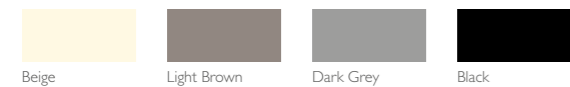





# Mykonos Lounge Armchair



Mykonos Lounge Armchair is designed for easy self assembly, it is made of durable weather-resistant resin reinforced with glass fiber. Non-metallic frame will never unravel, rust or decay. It is UV protected which insures the colors will not fade. Can be disassembled. For indoor and outdoor contract use.

131 Mykonos Lounge Armchair

**CATAS**  
TEST REPORT  
282199

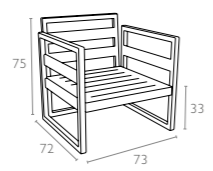

### Colors



## Mykonos Lounge Table



Mykonos Lounge Table is made of durable weather-resistant resin. Non-metallic frame will never unravel, rust or decay. It is UV protected which insures the colors will not fade. Can be disassembled. For indoor and outdoor use.

### 137 Mykonos Lounge Table

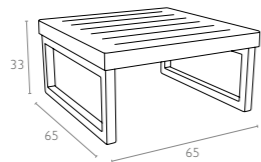

#### Colors



White

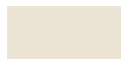

Taupe



Silver Grey



# Mykonos Lounge Table XL



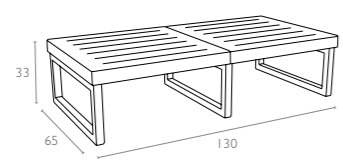

Mykonos Lounge Table XL is made of durable weather-resistant resin. Non-metallic frame will never unravel, rust or decay. It is UV protected which insures the colors will not fade. Can be disassembled. For indoor and outdoor use.

138 Mykonos Lounge Table XL



Colors

		
White	Taupe	Silver Grey



# Mykonos Extension Part



With the extension part you can add as many seats as you want to extend your corner set.

## 136 Mykonos Extension Part

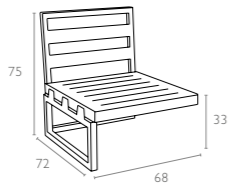

### Colors



White

Taupe

Silver Grey





Slim sunlounger is stackable and comes with hidden wheels and anti-slippery rubbers. It is made of durable weather-resistant resin. Non metallic frame will never unravel, rust or decay. It is UV protected which insures the colors will not fade. For outdoor use.

## 087 Slim

CATAS  
TEST REPORT

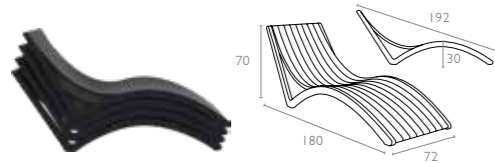

## Colors



White

Black

Dark Grey

Taupe





Sunlounger without arms, tubular frame in resin reinforced with glass fiber and cover in breathable synthetic fabric (replaceable). Stackable, back reclining in 5 positions, with non-slip feet and small wheels.

089 Pacific

CATAS  
TEST REPORT  
178495

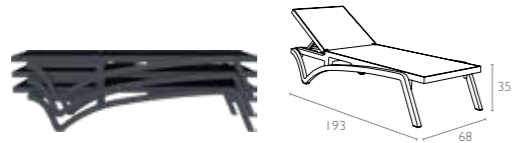

**Serge Ferrari**

Colors

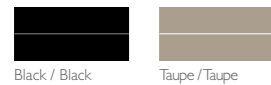
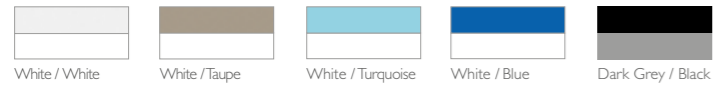

## Victor Bar 75



Victor bar stool h.75 cm is produced with a single injection of polypropylene reinforced with glass fiber obtained by means of the latest generation of air moulding technology with neutral tones. For indoor and outdoor use.

## 262 Victor Bar 75

CATAS  
TEST REPORT  
294882

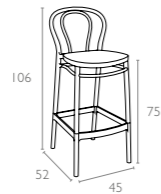

## Colors



White

Black

Dark Grey

Taupe

Olive Green





## Victor Bar 65



Victor bar stool h.65 cm is produced with a single injection of polypropylene reinforced with glass fiber obtained by means of the latest generation of air moulding technology with neutral tones. For indoor and outdoor use.

## 261 Victor Bar 65

CATAS  
TEST REPORT  
294882

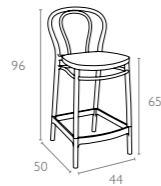

## Colors



## Cross Bar 75



Cross bar stool h.75 cm is produced with a single injection of polypropylene reinforced with glass fiber obtained by means of the latest generation of air moulding technology with neutral tones. For indoor and outdoor use.

## 266 Cross Bar 75

CATAS  
TEST REPORT  
294881

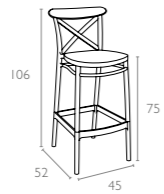

## Colors



White

Black

Dark Grey

Taupe

Olive Green



# Cross Bar 65



Cross bar stool h.65 cm is produced with a single injection of polypropylene reinforced with glass fiber obtained by means of the latest generation of air moulding technology with neutral tones. For indoor and outdoor use.

264 Cross Bar 65

**CATAS**  
TEST REPORT  
294881

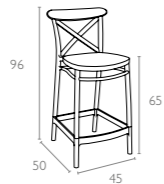

Colors



White    Black    Dark Grey    Taupe    Olive Green



## Marcel Bar 75



Marcel bar stool h.75 cm is produced with a single injection of polypropylene reinforced with glass fiber obtained by means of the latest generation of air moulding technology with neutral tones. For indoor and outdoor use.

## 269 Marcel Bar 75

CATAS  
TEST REPORT  
294883

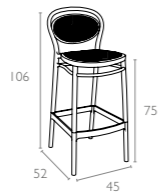

## Colors



White

Black

Dark Grey

Taupe

Olive Green



## Marcel Bar 65



Marcel bar stool h.65 cm is produced with a single injection of polypropylene reinforced with glass fiber obtained by means of the latest generation of air moulding technology with neutral tones. For indoor and outdoor use.

## 268 Marcel Bar 65

CATAS  
TEST REPORT  
294883

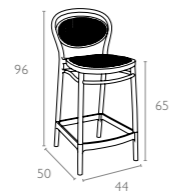

## Colors



White

Black

Dark Grey

Taupe

Olive Green



## Maya Bar 75



Maya stacking bar stool h.75 cm is produced with a single injection of polypropylene reinforced with glass fiber obtained by means of the latest generation of air moulding technology with neutral tones. For indoor and outdoor use.

099 Maya Bar 75

CATAS  
TEST REPORT  
236234

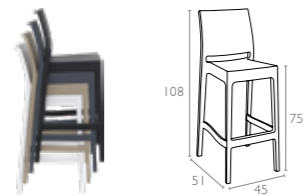

Colors



White

Black

Dark Grey

Taupe

Olive Green



## Maya Bar 65



Maya stacking bar stool h.65 cm is produced with a single injection of polypropylene reinforced with glass fiber obtained by means of the latest generation of air moulding technology with neutral tones. For indoor and outdoor use.

100 Maya Bar 65

CATAS  
TEST REPORT  
236234

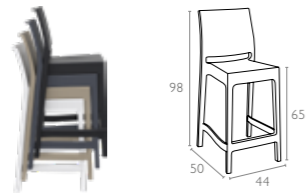

Colors



White

Black

Dark Grey

Taupe

Olive Green



## Ares Bar 75



Ares stacking bar stool h.75 cm is produced with a single injection of polypropylene reinforced with glass fiber obtained by means of the latest generation of air moulding technology with neutral tones. For indoor and outdoor use.

## 101 Ares Bar 75

CATAS  
TEST REPORT  
236235

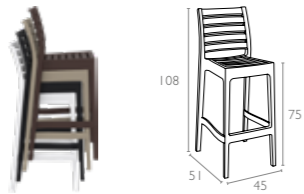

## Colors



White

Black

Dark Grey

Brown

Taupe





## Opera Bar 75



Stacking wedding bar stool h.75 cm for indoor and outdoor use in clear or shiny polycarbonate. Scratch resistant, UV - resistant.

## 073 Opera Bar 75

CATAS  
TEST REPORT  
226344

Made with  
**Makrolon®**  
The high-tech polycarbonate

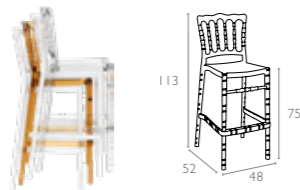

## Colors



Glossy White

Amber Transparent

Clear Transparent



## Opera Bar 65



Stacking wedding bar stool h.65 cm for indoor and outdoor use in clear or shiny polycarbonate. Scratch resistant, UV - resistant.

074 Opera Bar 65

CATAS  
TEST REPORT  
226344

Made with  
**Makrolon®**  
The high-tech polycarbonate

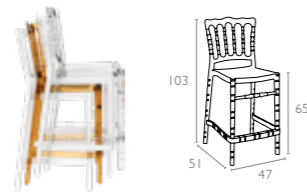

Colors



Glossy White

Amber Transparent

Clear Transparent



## Chiavari Bar 75



Stacking wedding bar stool h.75 cm for indoor and outdoor use in clear or shiny polycarbonate. Scratch resistant, UV - resistant.

083 Chiavari Bar 75

CATAS  
TEST REPORT  
226346

Made with  
**Makrolon®**  
The high-tech polycarbonate

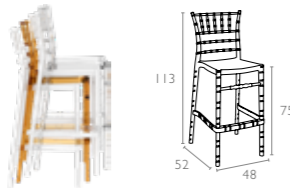

Colors



Glossy White

Amber Transparent

Clear Transparent



## Chiavari Bar 65



Stacking wedding bar stool h.65 cm for indoor and outdoor use in clear or shiny polycarbonate. Scratch resistant, UV - resistant.

084 Chiavari Bar 65

CATAS  
TEST REPORT  
226346

Made with  
**Makrolon®**  
The high-tech polycarbonate

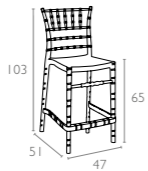

Colors



Glossy White



Amber Transparent



Clear Transparent





Stacking bar stool h.75 cm for indoor and outdoor use in shiny technopolymer PA6 nylon or clear polycarbonate. Scratch resistant, self - extinguish classification V2, UV - resistant.

037 Fox 75

CATAS  
TEST REPORT  
101129

Made with  
**Makrolon®**  
The high-tech polycarbonate



Colors

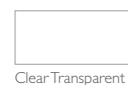
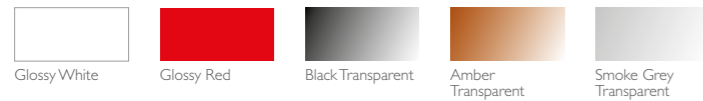

Clear Transparent





Stacking bar stool h.65 cm for indoor and outdoor use in shiny technopolymer PA6 nylon or clear polycarbonate. Scratch resistant, self - extinguish classification V2, UV - resistant.

036 Fox 65

CATAS  
TEST REPORT  
101129

Made with  
**Makrolon®**  
The high-tech polycarbonate



Colors



Glossy White

Glossy Red

Black Transparent

Clear Transparent



## Air Bar 75



Air Bar stool h.75 cm is produced with a single injection of polypropylene reinforced with glass fiber obtained by means of the latest generation of air moulding technology with neutral tones. For indoor and outdoor use.

068 Air Bar 75

CATAS  
TEST REPORT  
184081

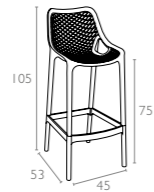

## Colors



White

Black

Dark Grey

Red

Taupe



Tropical Green



Orange





Air Bar stool h.65 cm is produced with a single injection of polypropylene reinforced with glass fiber obtained by means of the latest generation of air moulding technology with neutral tones. For indoor and outdoor use.

067 Air Bar 65

CATAS  
TEST REPORT  
184081

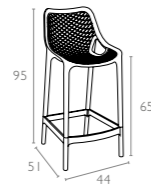

Colors



White

Black

Dark Grey

Red

Taupe



Tropical Green



Orange







Revolving stool with adjustable height with gas piston. Base and column in stainless steel. Seat in recyclable polycarbonate. For indoor use.

042 Aria

Made with  
**Makrolon®**  
The high-tech polycarbonate

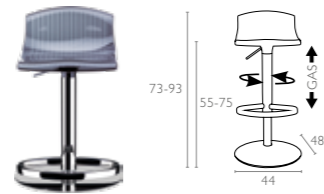

Colors



Glossy White

Red Transparent

Amber Transparent

Black Transparent

Clear Transparent





Stacking bar stool with recyclable polypropylene seat and backrest and square anodized aluminium legs. Diameter 25x25 mm. For indoor and outdoor use.

## 035 Gio 75

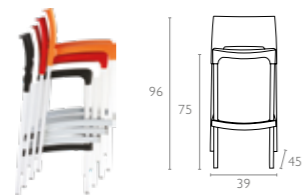

## Colors



Black

Light Green

Orange

Red

Beige

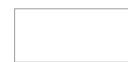

White



# Queen



Stacking side table for indoor and outdoor use in clear polycarbonate. UV - resistant.

065 Queen

Made with **Makrolon®**  
The high-tech polycarbonate

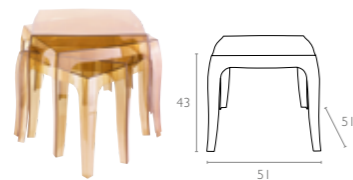

Colors

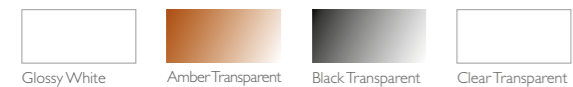

Glossy White    Amber Transparent    Black Transparent    Clear Transparent



## Sky Side Table



Sky Side Table is made of durable weather-resistant resin. Non-metallic frame will never unravel, rust or decay. It is UV protected which insures the colors will not fade. Can be disassembled. For indoor and outdoor use.

### 109 Sky Side Table

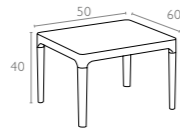

#### Colors



White

Black

Dark Grey

Taupe

Red



Yellow



# Sky Lounge Table



Sky Table is made of durable weather-resistant resin. Metallic frame will never unravel, rust or decay. It is UV protected which insures the colors will not fade. Can be disassembled. For indoor and outdoor use.

## 104 Sky Lounge Table

CATAS  
TEST REPORT  
257118

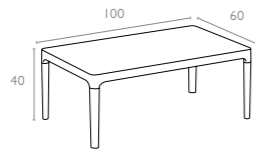

### Colors



White

Black

Dark Grey

Taupe

Red



Yellow



# Box Table



Stacking table in recyclable polypropylene.  
For indoor and outdoor use.

064 Box Table

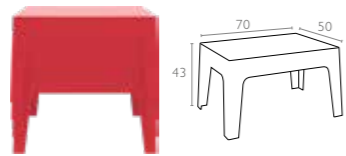

Colors

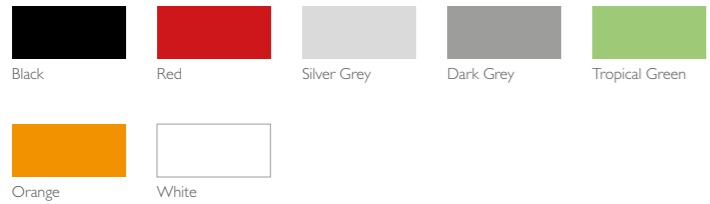

# Ocean Side Table



Ocean Side Table is made of durable weather-resistant resin. Non-metallic frame will never unravel, rust or decay. It is UV protected which insures the colors will not fade. Can be disassembled. For indoor and outdoor use.

066 Ocean Side Table

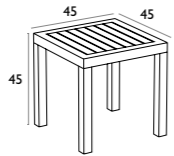

Colors



# Ocean Table



Ocean Lounge Table is made of durable weather-resistant resin. Non-metallic frame will never unravel, rust or decay. It is UV protected which insures the colors will not fade. Can be disassembled. For indoor and outdoor use.

## 069 Ocean Table

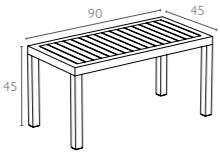

### Colors





## Vegas Table



Extendible table from 100 to 140 cm in polypropylene reinforced with glass fiber. Easily expandable, giving you a choice of two size options. Smart extending mechanism makes it easy to adjust the table to your preferred size. For indoor and outdoor use with UV protection.



## 772 Vegas Table

CATAS  
TEST REPORT  
253099

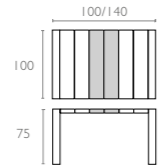

## Colors



White

Black

Dark Grey

Taupe



# Vegas Table Medium



Extendible table from 180 to 220 cm in polypropylene reinforced with glass fiber. Easily expandable, giving you a choice of two size options. Smart extending mechanism makes it easy to adjust the table to your preferred size. For indoor and outdoor use with UV protection.



774 Vegas Table Medium

CATAS  
TEST REPORT  
253098

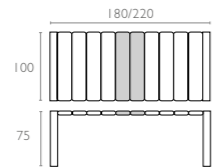

Colors



White

Black

Dark Grey

Taupe



## Vegas Table XL



Extendible table from 260 to 300 cm in polypropylene reinforced with glass fiber. Easily expandable, giving you a choice of two size options. Smart extending mechanism makes it easy to adjust the table to your preferred size. For indoor and outdoor use with UV protection.



776 Vegas Table XL

CATAS  
TEST REPORT  
253097

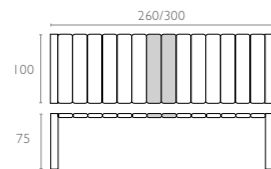

Colors



White



Black



Dark Grey

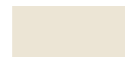

Taupe



## Sky Folding Table 60



Sky folding table is made of durable weather-resistant resin. Metallic frame will never unravel, rust or decay. It is UV protected which insures the colors will not fade. Can be disassembled. For indoor and outdoor use.

## 114 Sky Folding Table 60



## Colors



White

Black

Dark Grey

Taupe

Olive Green



## Sky Table 70



Sky Table is made of durable weather-resistant resin. Metallic frame will never unravel, rust or decay. It is UV protected which insures the colors will not fade. Can be disassembled. For indoor and outdoor use.

## 108 Sky Table 70

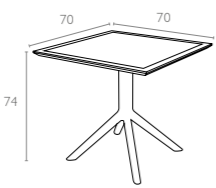

## Colors



White

Black

Dark Grey

Taupe

Olive Green



## Sky Table 80



Sky Table is made of durable weather-resistant resin. Metallic frame will never unravel, rust or decay. It is UV protected which insures the colors will not fade. Can be disassembled. For indoor and outdoor use.

## 106 Sky Table 80

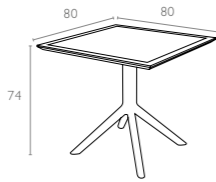

## Colors



White

Black

Dark Grey

Taupe

Olive Green



## Air Table 80



Table with plastic legs with HPL compact laminated tops 12 mm available in white and black. For indoor and outdoor use. Can be disassembled.

\* Dark colors not recommended in direct sunlight.

## 700 Air Table 80

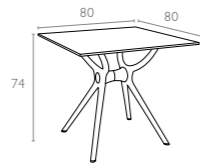

## Colors



White



Black



# Air Table I 40



Table with plastic legs with HPL compact laminated tops 12 mm available in white and black. For indoor and outdoor use. Can be disassembled.

*\* Dark colors not recommended in direct sunlight.*

## 705 Air Table I 40

---



### Colors



White



Black





# Air Table 180



Table with plastic legs with HPL compact laminated tops 12 mm available in white and black. For indoor and outdoor use. Can be disassembled.

*\* Dark colors not recommended in direct sunlight.*

715 Air Table 180

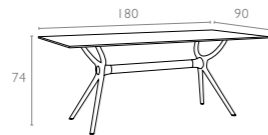

Colors



White



Black



## Sky Folding Legs



Sky folding leg is made of durable weather-resistant resin. Metallic frame will never unravel, rust or decay. It is UV protected which insures the colors will not fade. Can be disassembled and suitable for werzalit or HPL compact tops. For indoor and outdoor use.

### 118 Sky Folding Legs

Top min: 50x50 cm  
Top max: 70x70 cm

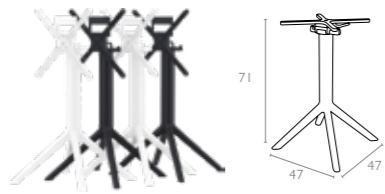

#### Colors



White



Black



# Sky Legs



Sky leg is made of durable weather-resistant resin. Metallic frame will never unravel, rust or decay. It is UV protected which insures the colors will not fade. Can be disassembled and suitable for werzalit or HPL compact tops. For indoor and outdoor use.

## 107 Sky Legs

Top min : 70x70 cm  
Top max : 90x90 cm

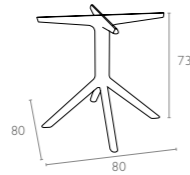

### Colors



White

Black

Dark Grey

Taupe





### 335 Air Legs Small

\* Top min. 70x70 cm, Top max. 90x90 cm

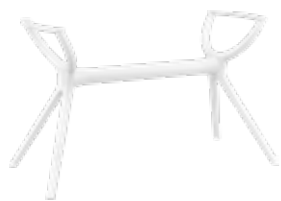
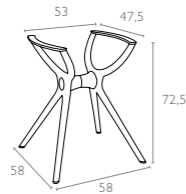

### 336 Air Legs Medium

\* Top min. 70x120 cm, Top max. 80x160 cm

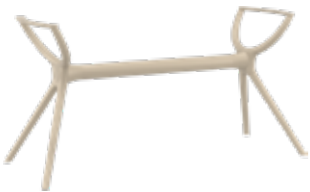
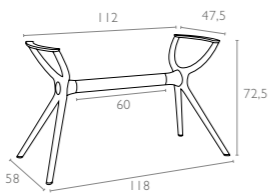

### 337 Air Legs XL

\* Top min 90x180 cm, Top max 100x200 cm

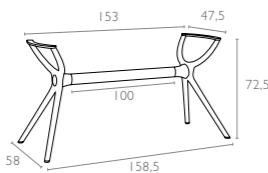

Air Legs are made up of polypropylene reinforced with glass fiber with the latest generation of air moulding thermoplastic injection. For indoor and outdoor use. Can be disassembled.

#### Colors



White



Black



Taupe



# Octopus 60



Octopus table is made of durable weather-resistant resin. Metallic frame will never unravel, rust or decay. It is UV protected which insures the colors will not fade. Can be disassembled. For indoor and outdoor use.

## 160 Octopus 60



### Colors



## Octopus Bar



Octopus Bar table is made of durable weather-resistant resin. Metallic frame will never unravel, rust or decay. It is UV protected which insures the colors will not fade. Can be disassembled. For indoor and outdoor use.

## 161 Octopus Bar



## Colors



Black

Dark Grey

Taupe

White



# Sky Folding Bar Table 60



Sky folding bar table is made of durable weather-resistant resin. Metallic frame will never unravel, rust or decay. It is UV protected which insures the colors will not fade. Can be disassembled. For indoor and outdoor use.

116 Sky Folding Bar Table 60



Colors



White    Black    Dark Grey    Taupe    Olive Green



# Ares 80



Ares 80 table is made of durable weather-resistant resin. Non-metallic frame will never unravel, rust or decay. It is UV protected which insures the colors will not fade. Can be disassembled. For indoor and outdoor use.

164 Ares 80

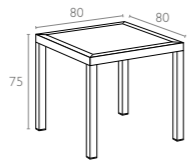

Colors

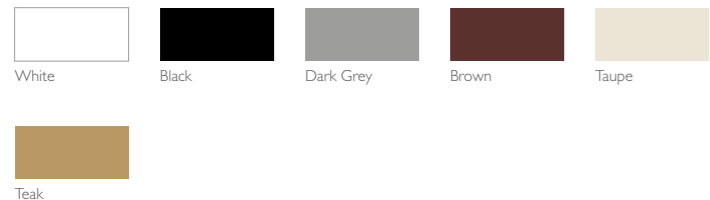



# Ares 140



Ares 140 table is made of durable weather-resistant resin. Non-metallic frame will never unravel, rust or decay. It is UV protected which insures the colors will not fade. Can be disassembled. For indoor and outdoor use.

186 Ares 140

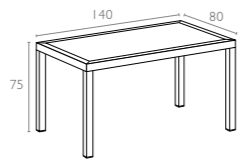

Colors

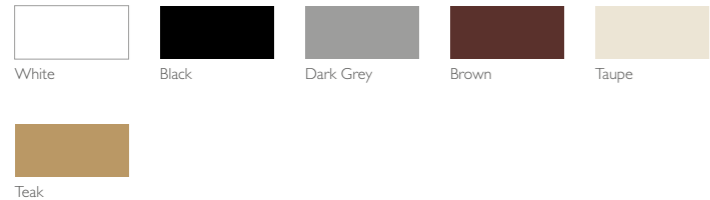



685 Maya 80

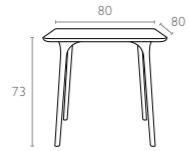

675 Maya 120



690 Maya 140

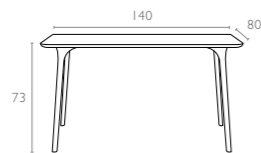

HPL compact laminated tops  
12 mm with the latest generation of  
air moulding thermoplastic legs.  
For indoor and outdoor use.  
Can be disassembled.

\* Dark colors not recommended in direct sunlight.



#### Colors



White



Black







# Ice



500 - 510 - 520 Ice

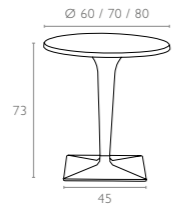

550 - 560 Ice

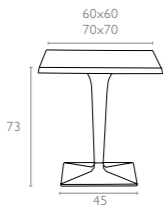

Table with clear transparent polycarbonate leg and painted aluminium base. Werzalit tops, resistant to outdoor use, available in white, black and silver grey. For indoor and outdoor use.



### Colors



White      Black      Silver Grey





# Ice Leg & Base



Clear transparent polycarbonate leg and painted aluminium base.  
For indoor and outdoor use.

310 Ice Leg & Base

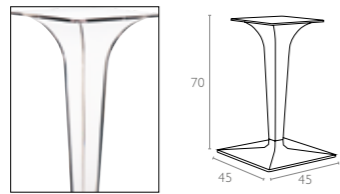

Made with **Makrolon**<sup>®</sup>  
The high-tech polycarbonate

Colors



Clear Transparent



# Mango



Stacking table with the latest generation of air moulding thermoplastic injection. For indoor and outdoor use.

800 Mango

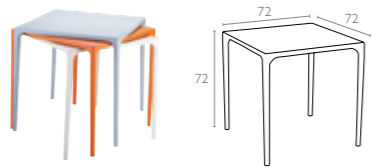

**Colors**





## Mango Alu



Stacking table with the latest generation of air moulding thermoplastic injection with legs in anodized aluminium. For indoor and outdoor use.

## 758 Mango Alu

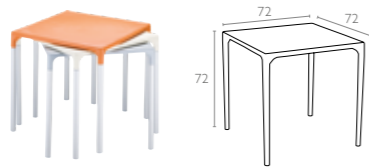

## Colors



White

Beige

Orange

Silver Grey



# Forza



Folding table with legs in anodized aluminium. Diameter 30 mm. Table top in recyclable polypropylene. For indoor and outdoor use.

## 770 Forza



### Colors

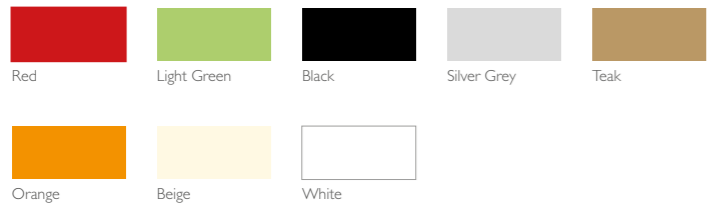

# Sortie



Table top in recyclable polypropylene, anodized aluminium legs.  
 Diameter 25 mm. For indoor and outdoor use. Can be disassembled.

## 750 Sortie

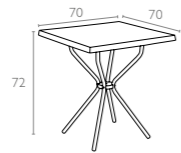

### Colors



Black

Red

Light Green

Orange

Beige



White



# Poppy 80



Table top in recyclable polypropylene, anodized aluminium legs.  
 Diameter 25 mm. For indoor and outdoor use. Can be disassembled.

720 Poppy 80

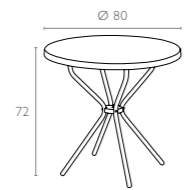

Colors



White



## Elfo 70



Table top in recyclable polypropylene, anodized aluminium legs.  
Diameter 25 mm. For indoor and outdoor use. Can be disassembled.

710 Elfo 70

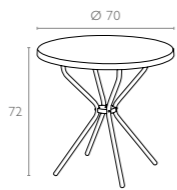

## Colors



Black

Red

Light Green

Orange

Beige



White



# Dodo



Suspension lamp in polycarbonate with 25W energy saving lamp. The diffuser can be removed without dismantling the electrical body, for an easy fitting and removal.

415 Dodo



Made with **Makrolon**<sup>®</sup>  
The high-tech polycarbonate

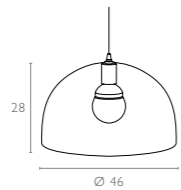

Colors

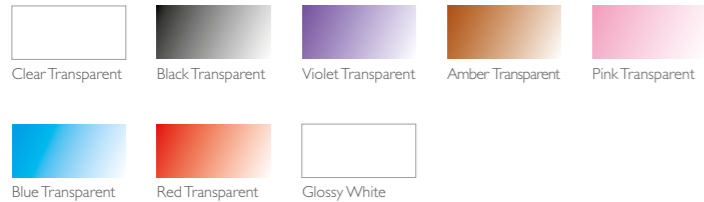

# Nova



Suspension lamp in polycarbonate with 25W energy saving lamp. The diffuser can be removed without dismantling the electrical body, for an easy fitting and removal.

410 Nova



Made with **Makrolon**<sup>®</sup>  
The high-tech polycarbonate

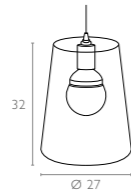

Colors

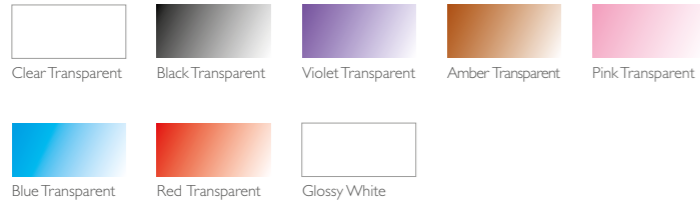

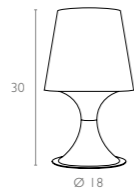

Table lamp made of transparent or coloured injected polycarbonate, with 40W lamp. Perfect gift idea.

420 Smart

CE

Made with  
**Makrolon®**  
The high-tech polycarbonate



Colors



Clear Transparent Black Transparent Violet Transparent Amber Transparent Pink Transparent



Blue Transparent Red Transparent Glossy White





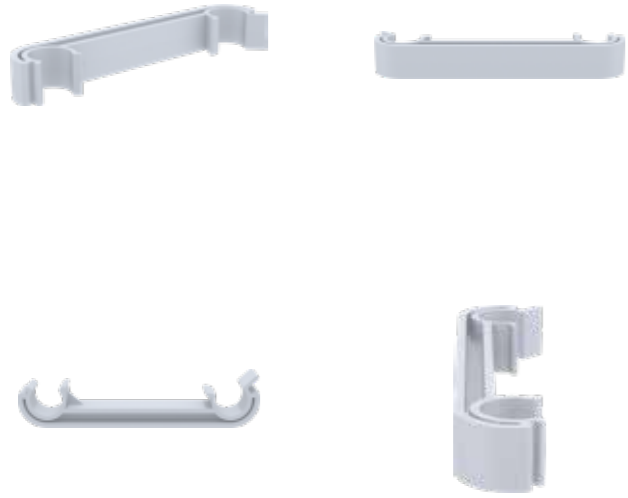

Link linking device in polypropylene to be fixed on the frame.  
Suitable for all round legs Ø 25mm.

097 Link

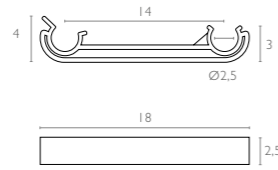

Colors



Silver Grey



# Artemis XL Cushions



5 cm thick seat and backrest cushion covered with polyester fabric and finished with piping. Cushion is specially designed for Artemis XL armchair.

899 Artemis XL Seat Cushion

900 Artemis XL Backrest Cushion

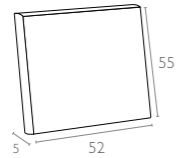
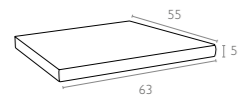

Cushion Colors

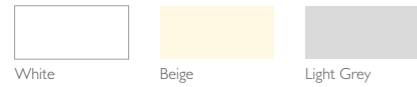

White

Beige

Light Grey



# Mykonos Cushions



10 cm thick cushion covered with Etisilk polyester fabric and finished with piping. Cushions are specially designed for Mykonos Lounge Set. Water resistant with UV.



141 Mykonos Seat Cushion

142 Mykonos Backrest Cushion

143 Mykonos Corner Cushion

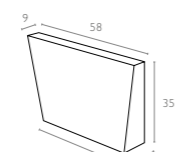
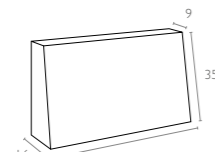
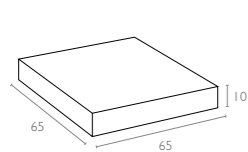

**Cushion Colors**

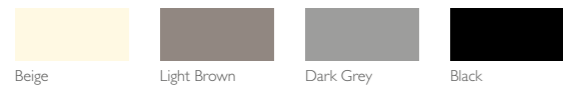

Beige    Light Brown    Dark Grey    Black



# Slim Cushions

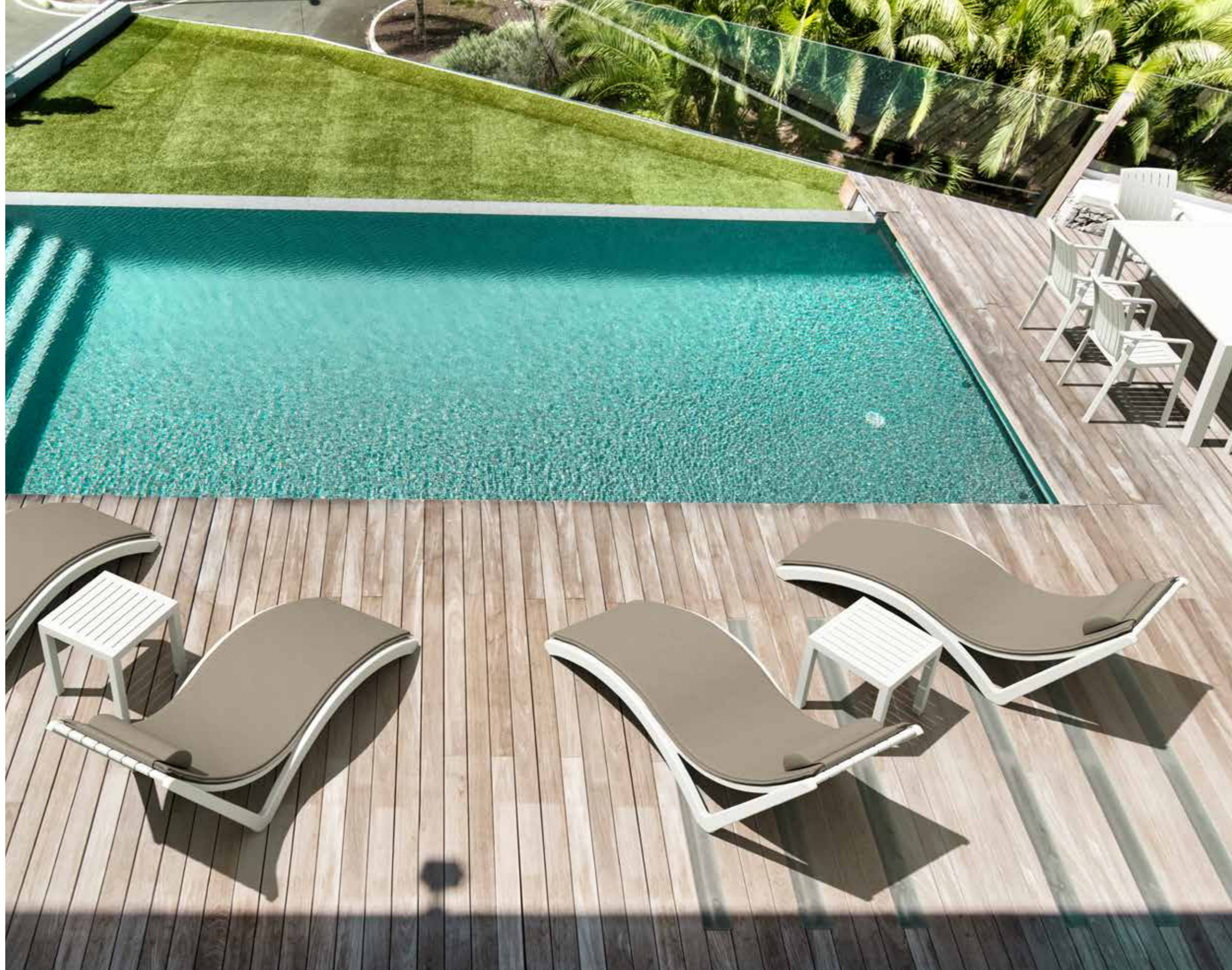

3 cm thick Slim cushion and 5 cm thick Slim pillow cushion covered with Etisilk polyester fabric and finished with piping. Cushions are specially designed for Slim sunlounger Water resistant with UV.



144 Slim Cushion

148 Slim Pillow Cushion

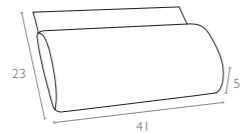
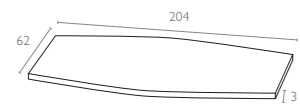

### Cushion Colors

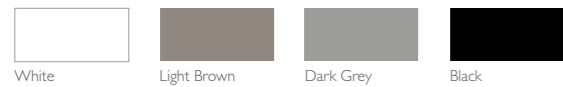

White    Light Brown    Dark Grey    Black

### 102 SKY

Sky armchair is produced with recyclable polypropylene seat and legs reinforced with glass fiber. For indoor and outdoor use. Can be disassembled.



White



Dark Grey



Black



Taupe



Red



Yellow

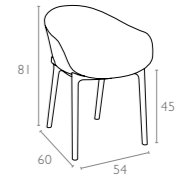

### 103 SKY LOUNGE

Sky lounge chair is produced with recyclable polypropylene seat and legs reinforced with glass fiber. For indoor and outdoor use. Can be disassembled.



White



Dark Grey



Black



Taupe



Red



Yellow

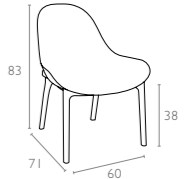
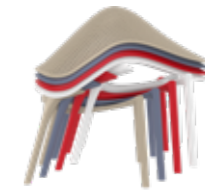

### 023 PACIFIC ARMCHAIR

Pacific armchair with Batyline fabric from Serge Ferrari is made from a weather-proof, UV-protected resin reinforced by glass fiber that stands up to summer showers and strong sun, making it the ideal, worry-free addition to your outdoor seating area. This versatile armchair pairs perfectly with the Pacific sunlounger, as well as a wide range of other outdoor tables. For domestic or commercial use.



White  
White



Black  
Black



Dark Grey  
Black



Taupe  
Taupe

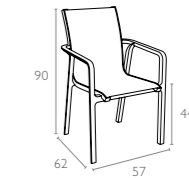

### 013 SLIM ARMCHAIR

Slim armchair is made from a weather-proof, UV-protected resin reinforced by glass fiber that stands up to summer showers and strong sun, making it the ideal, worry-free addition to your outdoor seating area. This versatile armchair pairs perfectly with the Slim sunlounger, as well as a wide range of other outdoor tables. For domestic or commercial use.



White



Black



Dark Grey



Taupe

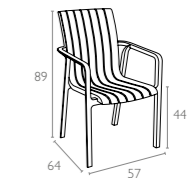

### 251 MARIE

Marie stacking chair is produced with a single injection of polypropylene reinforced with glass fiber obtained by means of the latest generation of air moulding technology with neutral tones. For indoor and outdoor use.



White



Black



Olive Green

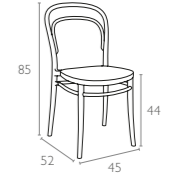

### 252 VICTOR

Victor stacking chair is produced with a single injection of polypropylene reinforced with glass fiber obtained by means of the latest generation of air moulding technology with neutral tones. For indoor and outdoor use.



White



Dark Grey



Black



Taupe



Olive Green

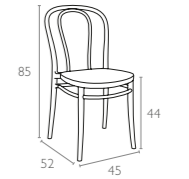

### 253 VICTOR XL

Victor XL stacking armchair is produced with a single injection of polypropylene reinforced with glass fiber obtained by means of the latest generation of air moulding technology with neutral tones. For indoor and outdoor use.



White



Dark Grey



Black



Taupe



Olive Green

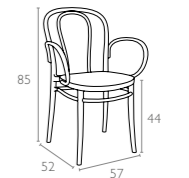

### 254 CROSS

Cross stacking chair is produced with a single injection of polypropylene reinforced with glass fiber obtained by means of the latest generation of air moulding technology with neutral tones. For indoor and outdoor use.



White



Dark Grey



Black



Taupe



Olive Green

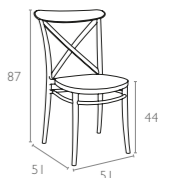

### 256 CROSS XL

Cross XL stacking armchair is produced with a single injection of polypropylene reinforced with glass fiber obtained by means of the latest generation of air moulding technology with neutral tones. For indoor and outdoor use.



White



Dark Grey



Black



Taupe



Olive Green

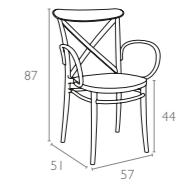

### 257 MARCEL

Marcel stacking chair is produced with a single injection of polypropylene reinforced with glass fiber obtained by means of the latest generation of air moulding technology with neutral tones. For indoor and outdoor use.



White



Dark Grey



Black



Taupe



Olive Green

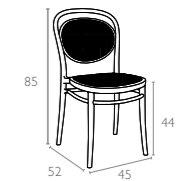

### 258 MARCEL XL

Marcel XL stacking armchair is produced with a single injection of polypropylene reinforced with glass fiber obtained by means of the latest generation of air moulding technology with neutral tones. For indoor and outdoor use.



White



Dark Grey



Black



Taupe



Olive Green

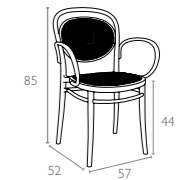

### 079 DREAM

Dream folding chair is produced with a single injection of polypropylene reinforced with glass fiber obtained by means of the latest generation of air moulding technology with neutral tones. For indoor and outdoor use.



White



Dark Grey



Black



Taupe



Red



Olive Green

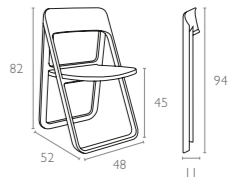

designed by  
Frédéric Boonen  
**bds**



## 127 MONNA

Monna chair is produced with a single injection of polypropylene reinforced with glass fiber obtained by means of the latest generation of air moulding technology with neutral tones. For indoor and outdoor use.

CATAS  
TEST REPORT  
276554



White



Dark Grey



Black



Taupe



Red



Olive Green

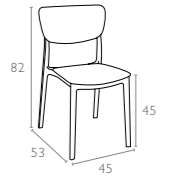

## 126 LISA

Lisa armchair is produced with a single injection of polypropylene reinforced with glass fiber obtained by means of the latest generation of air moulding technology with neutral tones. For indoor and outdoor use.

CATAS  
TEST REPORT  
276570



White



Dark Grey



Black



Taupe



Red



Olive Green

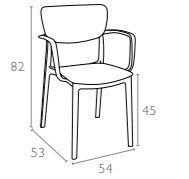

## 129 LUCY

Lucy chair is produced with a single injection of polypropylene reinforced with glass fiber obtained by means of the latest generation of air moulding technology with neutral tones. For indoor and outdoor use.

CATAS  
TEST REPORT  
276562



White



Dark Grey



Black



Taupe



Olive Green

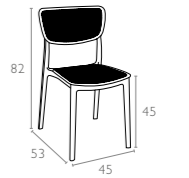

## 128 LOFT

Loft armchair is produced with a single injection of polypropylene reinforced with glass fiber obtained by means of the latest generation of air moulding technology with neutral tones. For indoor and outdoor use.

CATAS  
TEST REPORT  
276563



White



Dark Grey



Black



Taupe



Olive Green

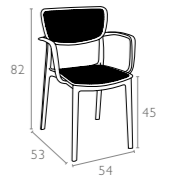



## 085 MILA

Mila armchair is produced with a single injection of polypropylene reinforced with glass fiber obtained by means of the latest generation of air moulding technology with neutral tones. For indoor and outdoor use.

CATAS  
TEST REPORT  
233341



White



Dark Grey



Black



Taupe



Red



Yellow

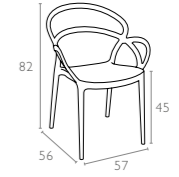

## 086 PIA

Pia chair is produced with a single injection of polypropylene reinforced with glass fiber obtained by means of the latest generation of air moulding technology with neutral tones. For indoor and outdoor use.

CATAS  
TEST REPORT  
233342



White



Dark Grey



Black



Taupe



Red



Yellow

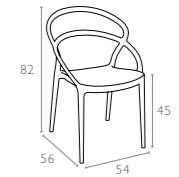

## 088 SUNSET

Sunset chair is produced with a single injection of polypropylene reinforced with glass fiber obtained by means of the latest generation of air moulding technology with neutral tones. For indoor and outdoor use.

CATAS  
TEST REPORT  
233343



White



Dark Grey



Black



Brown



Taupe

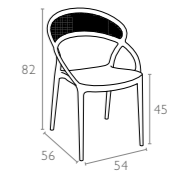

## 093 PLUS

Plus armchair is produced with a single injection of polypropylene reinforced with glass fiber obtained by means of the latest generation of air moulding technology with neutral tones. For indoor and outdoor use.

CATAS  
TEST REPORT  
235829



White



Black



Red

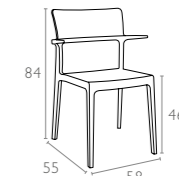

### 092 SNOW

Snow chair is produced with a single injection of polypropylene reinforced with glass fiber obtained by means of the latest generation of air moulding technology with neutral tones. For indoor and outdoor use.



White



Dark Grey



Black



Taupe



Red



Yellow



Olive Green

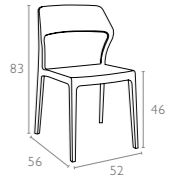

### 090 MOON

Stacking chair with the latest generation of air moulding thermoplastic injection. Seat in polypropylene reinforced with glass fiber, backrest in transparent polycarbonate. For indoor and outdoor use.



White Glossy White



White Amber Transparent



White Red Transparent



White Clear Transparent



Black Clear Transparent



Black Black Transparent



Black Amber Transparent



Black Red Transparent

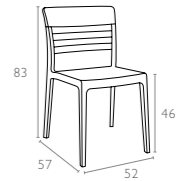

### 091 FLASH

Stacking chair with the latest generation of air moulding thermoplastic injection. Seat in polypropylene reinforced with glass fiber, backrest in transparent polycarbonate. For indoor and outdoor use.



White Glossy White



White Amber Transparent



White Red Transparent



White Clear Transparent



Black Clear Transparent



Black Black Transparent



Black Amber Transparent



Black Red Transparent

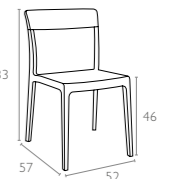

### 048 BLOOM

Bloom chair is produced with a single injection of polypropylene reinforced with glass fiber obtained by means of the latest generation of air moulding technology with neutral tones. For indoor and outdoor use.



White



Dark Grey



Silver Grey



Black



Taupe



Red



Yellow

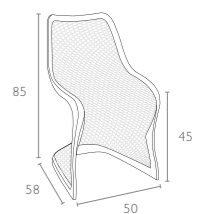

## 007 AIR XL

Air XL armchair is produced with a single injection of polypropylene reinforced with glass fiber obtained by means of the latest generation of air moulding technology with neutral tones. For indoor and outdoor use.

CATAS  
TEST REPORT  
182331



White



Orange



Dark Grey



Black



Taupe



Red



Tropical Green



Yellow

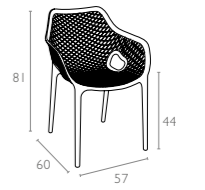

## 014 AIR

Air chair is produced with a single injection of polypropylene reinforced with glass fiber obtained by means of the latest generation of air moulding technology with neutral tones. For indoor and outdoor use.

CATAS  
TEST REPORT  
163635



White



Orange



Dark Grey



Black



Taupe



Red



Tropical Green



Yellow

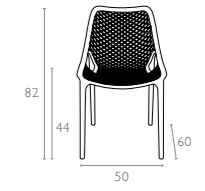

## 039 MIRANDA

Miranda chair is produced with a single injection of polypropylene reinforced with glass fiber obtained by means of the latest generation of air moulding technology with neutral tones. For indoor and outdoor use.

CATAS  
TEST REPORT  
201779



White



Dark Grey



Black



Brown



Taupe

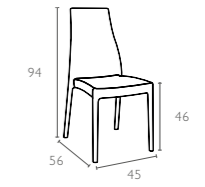

## 054 SOHO

Soho chair is produced with a single injection of polypropylene reinforced with glass fiber obtained by means of the latest generation of air moulding technology with neutral tones. For indoor and outdoor use.

CATAS  
TEST REPORT  
201772



White



Dark Grey



Black



Brown



Taupe



Red

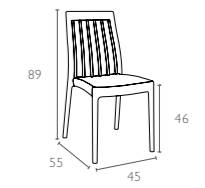

## 050 JOSEPHINE

Josephine wedding chair is produced with a single injection of polypropylene reinforced with glass fiber obtained by means of the latest generation of air moulding technology with neutral tones. For indoor and outdoor use.

CATAS  
TEST REPORT  
201775



White



Black

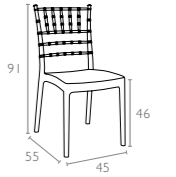

## 044 NAPOLEON

Napoleon wedding chair is produced with a single injection of polypropylene reinforced with glass fiber obtained by means of the latest generation of air moulding technology with neutral tones. For indoor and outdoor use.

CATAS  
TEST REPORT  
201775



White



Silver Grey



Black



Gold

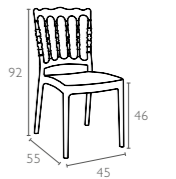

## 061 OPERA

Stacking wedding chair for indoor and outdoor use in clear or shiny polycarbonate. Scratch resistant, UV - resistant.

CATAS  
TEST REPORT  
226345

Made with  
**Makrolon®**  
The high-tech polycarbonate



Glossy White



Amber Transparent



Clear Transparent

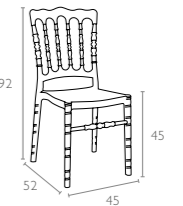

## 071 CHIAVARI

Stacking wedding chair for indoor and outdoor use in clear or shiny polycarbonate. Scratch resistant, UV - resistant.

CATAS  
TEST REPORT  
226347

Made with  
**Makrolon®**  
The high-tech polycarbonate



Glossy White



Amber Transparent



Clear Transparent

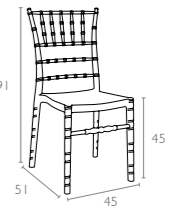

### 052 CRYSTAL

Stacking armchair for indoor and outdoor use in clear polycarbonate moulded with gas technology of the second generation. Scratch resistant, UV - resistant.



Glossy White    Clear Transparent    Smoke Grey Transparent    Black Transparent    Orange Transparent    Amber Transparent    Red Transparent

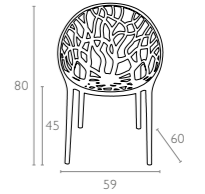
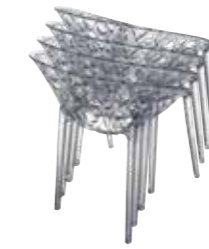

### 034 ELIZABETH

Stacking chair for indoor and outdoor use in shiny technopolymer PA6 nylon or clear polycarbonate. Scratch resistant, self - extinguish classification V2, UV - resistant.

\* On request with cushion.



Glossy White    Glossy Red    Glossy Black    Clear Transparent    Black Transparent    Amber Transparent    Pink Transparent    \* Black Transparent

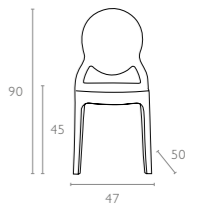

### 051 BABY ELIZABETH

Stacking children chair Baby Elizabeth for indoor and outdoor use in clear polycarbonate. Scratch resistant, UV - resistant.



Glossy White    Clear Transparent    Pink Transparent    Violet Transparent    Red Transparent    Blue Transparent

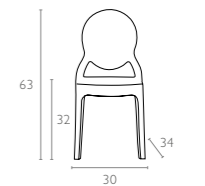

### 053 ARTHUR

Stacking armchair for indoor and outdoor use in shiny technopolymer PA6 nylon or clear polycarbonate. Scratch resistant, self - extinguish classification V2, UV - resistant.



Glossy White    Glossy Red    Glossy Black    Clear Transparent    Black Transparent    Amber Transparent

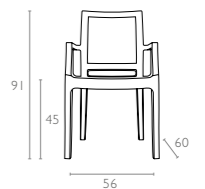

### 005 BO

Stacking chair for indoor and outdoor use in clear or shiny polycarbonate. Scratch resistant, UV - resistant.



Glossy White

Glossy Black

Clear Transparent

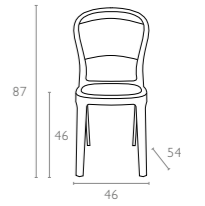
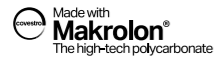

### 021 BEE

Stacking chair for indoor and outdoor use in clear or shiny polycarbonate. Scratch resistant, UV - resistant.



Glossy White

Glossy Black

Clear Transparent

Black Transparent

Amber Transparent

Red Transparent

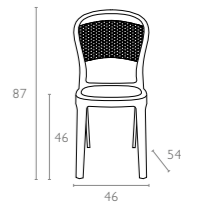

### 055 Miss BIBI

Stacking chair with the latest generation of air moulding thermoplastic injection. Seat in polypropylene reinforced with glass fiber, backrest in transparent polycarbonate. For indoor and outdoor use.



White Clear Transparent

White Amber Transparent

White Black Transparent

White Red Transparent

White Violet Transparent

Dark Grey Clear Transparent

Dark Grey Smoke Grey Transparent

Black Clear Transparent

Black Amber Transparent

Black Black Transparent

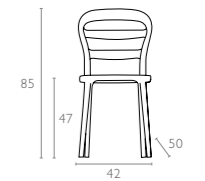

### 056 Mr BOBO

Stacking chair with the latest generation of air moulding thermoplastic injection. Seat in polypropylene reinforced with glass fiber, backrest in transparent polycarbonate. For indoor and outdoor use.



White Clear Transparent

White Amber Transparent

White Black Transparent

Dark Grey Clear Transparent

Dark Grey Smoke Grey Transparent

Black Clear Transparent

Black Black Transparent

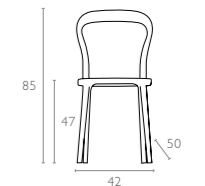

### 059 CARMEN

Stacking armchair with the latest generation of air moulding thermoplastic injection. Seat in polypropylene reinforced with glass fiber, backrest in transparent polycarbonate. For indoor and outdoor use.



White Glossy White

White Clear Transparent

White Amber Transparent

White Black Transparent

White Red Transparent



White Violet Transparent

Black Clear Transparent

Black Black Transparent

Black Amber Transparent

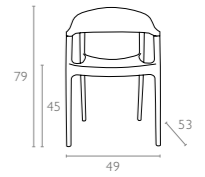

### 057 ALLEGRA

Recyclable polycarbonate main body. Legs frame in tubular chrome steel. Stackable. For indoor use.



Glossy White

Clear Transparent

Black Transparent

Amber Transparent

Red Transparent

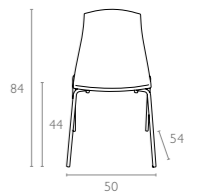

### 096 ALLEGRA-PP

Recyclable polycarbonate main body. Legs frame in polypropylene. For indoor and outdoor use. Can be disassembled.



White Glossy White

Black Black Transparent

Brown Glossy White

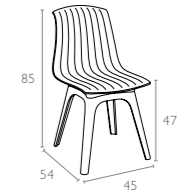

### 094 MIO-PP

Mio-PP chair is produced with recyclable polypropylene seat and legs reinforced with glass fiber. For indoor and outdoor use. Can be disassembled.



White White

Black Black

Brown White

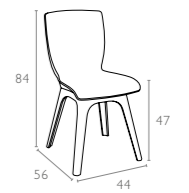

**046 MIO**

Stacking chair with recyclable polypropylene seat and backrest and painted steel legs. For indoor use.



White



Beige



Red



Orange

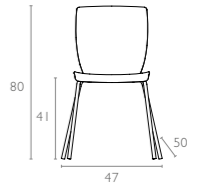

Black

**025 MAYA**

Stacking chair with the latest generation of air moulding thermoplastic injection. For indoor and outdoor use.



White



Orange



Silver Grey



Black



Light Blue



Dark Grey



Tropical Green



Olive Green

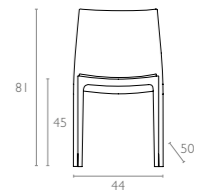

**CATAS**  
TEST REPORT  
73610

**028 DIVA**

Diva armchair is produced with a single injection of polypropylene reinforced with glass fiber obtained by means of the latest generation of air moulding technology with neutral tones. For indoor and outdoor use.



White



Orange



Silver Grey



Black



Light Blue



Dark Grey



Red



Tropical Green

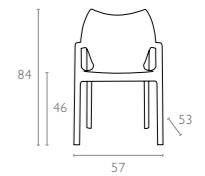

**CATAS**  
TEST REPORT  
101128

**058 BOX**

Recyclable polypropylene stacking armchair, strong and stable. Suitable for outdoor contract use.



White



Silver Grey



Dark Grey



Black



Red



Orange



Tropical Green

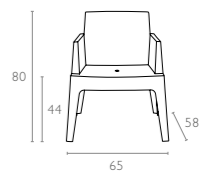

**CATAS**  
TEST REPORT  
117039



### 063 BOX SOFA

Recyclable polypropylene stackable sofa, very sturdy and stable. Suitable for outdoor contract use.



White Silver Grey Dark Grey Black Red Orange Tropical Green

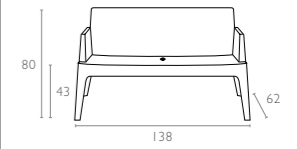

### 009 ARES

Ares chair is produced with a single injection of polypropylene reinforced with glass fiber obtained by means of the latest generation of air moulding technology with neutral tones. For indoor and outdoor use.



White Taupe Teak Brown Silver Grey Dark Grey Black

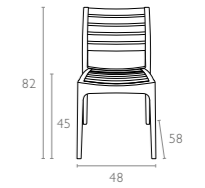

### 011 ARTEMIS

Artemis armchair is produced with a single injection of polypropylene reinforced with glass fiber obtained by means of the latest generation of air moulding technology with neutral tones. For indoor and outdoor use.



White Taupe Teak Brown Silver Grey Dark Grey Black

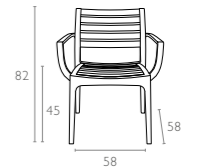

### 004 ARTEMIS XL

Artemis XL Lounge armchair is stackable and produced with a single injection of polypropylene reinforced with glass fiber, for indoor and outdoor use with or without cushion and non-slip feet. The Artemis collection also includes a coffee table, in various sizes, designed to match the styling silhouette of the chair to perfection.



White Taupe Silver Grey Dark Grey Black

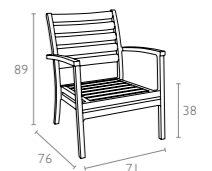

### 018 TIFFANY

Tiffany chair is produced with a single injection of polypropylene reinforced with glass fiber obtained by means of the latest generation of air moulding technology with neutral tones. Stackable. For indoor and outdoor use.



White



Orange



Silver Grey



Black



Light Blue



Dark Grey



Brown



Tropical Green

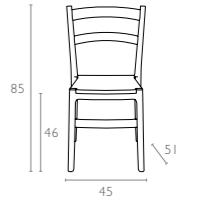

### 019 TIFFANY-S

Tiffany-S chair is produced with a single injection of polypropylene reinforced with glass fiber obtained by means of the latest generation of air moulding technology with neutral tones. Stackable. For indoor and outdoor use.



White



Light Blue



Dark Grey



Brown

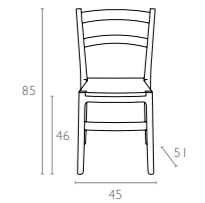

### 026 LUCCA

Stacking chair with the latest generation of air moulding thermoplastic injection. For indoor and outdoor use.



White



Orange



Silver Grey



Light Blue



Dark Grey



Tropical Green

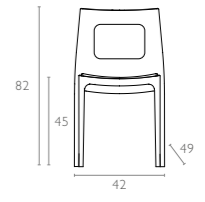

### 029 LUCCA-T

Stacking chair with the latest generation of air moulding thermoplastic injection. Back in transparent polycarbonate. For indoor and outdoor use.



White



Orange



Light Blue

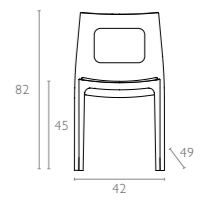

**047 DOLCE**

Stacking armchair with recyclable polypropylene seat and backrest and anodized aluminium legs. Diameter 25 mm. For indoor and outdoor use.



White



Beige



Red



Orange



Light Green



Dark Grey

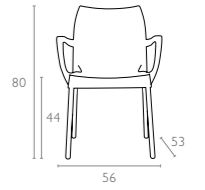

Black

**049 VITA**

Stacking chair with recyclable polypropylene seat and backrest and anodized aluminium legs. Diameter 25 mm. For indoor and outdoor use.



White



Beige



Red



Orange



Light Green



Dark Grey

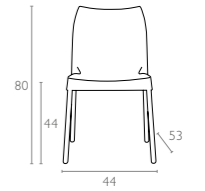

Black

**043 ROMEO**

Stacking armchair with recyclable polypropylene seat and backrest and anodized aluminium legs. Diameter 25 mm. For indoor and outdoor use.



White



Beige



Red



Orange



Light Green



Black

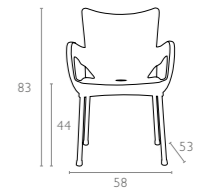

Blue

**045 JULIETTE**

Stacking chair with recyclable polypropylene seat and backrest and anodized aluminium legs. Diameter 25 mm. For indoor and outdoor use.



White



Beige



Red



Orange



Light Green



Black



Blue

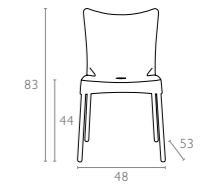

### 041 GALA

Stacking armchair in anodized aluminium with seat and back in recyclable polypropylene with latest generation of air moulding thermoplastic injection. Diameter 25 mm. For indoor and outdoor use.



White

Orange

Teak

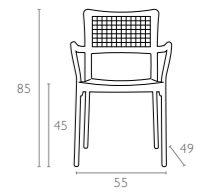

### 040 BELLA

Stacking armchair in anodized aluminium with seat and back in recyclable polypropylene with latest generation of air moulding thermoplastic injection. Diameter 25 mm. For indoor and outdoor use.



White

Orange

Teak

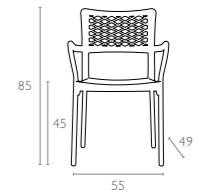

### 133 MYKONOS LOUNGE SET XL

Mykonos Lounge Set XL is designed for easy self assembly, it is made of durable weather-resistant resin reinforced with glass fiber. Non-metallic frame will never unravel, rust or decay. It is UV protected which insures the colors will not fade. Can be disassembled. For indoor and outdoor contract use.



White



Silver Grey



Taupe

Mykonos Lounge Armchair  
2 pcs

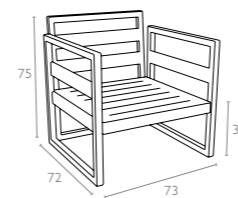

Mykonos Lounge Sofa XL  
1 pcs

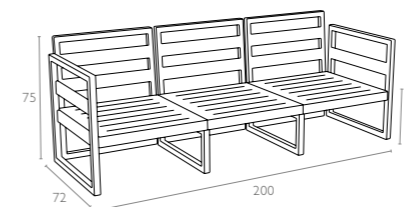

Mykonos Lounge Table XL  
1 pcs

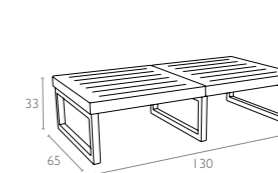

Mykonos Seat Cushion  
5 pcs

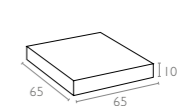

Mykonos Backrest Cushion  
5 pcs

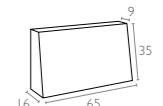

\* Can be purchased with or without cushions.



## 132 MYKONOS LOUNGE SET

Mykonos Lounge Set is designed for easy self assembly, it is made of durable weather-resistant resin reinforced with glass fiber. Non-metallic frame will never unravel, rust or decay. It is UV protected which insures the colors will not fade. Can be disassembled. For indoor and outdoor contract use.



White



Silver Grey



Taupe



Mykonos Lounge Armchair  
2 pcs

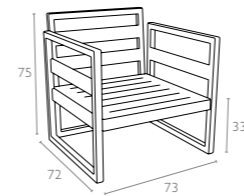

Mykonos Lounge Sofa  
1 pcs

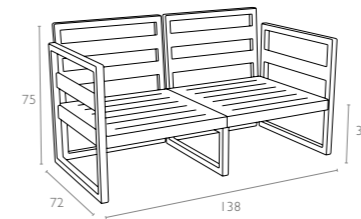

Mykonos Lounge Table  
1 pcs

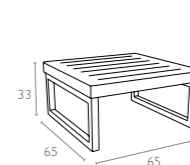

Mykonos Seat Cushion  
4 pcs

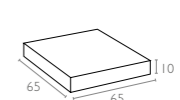

Mykonos Backrest Cushion  
4 pcs

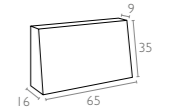

\* Can be purchased with or without cushions.



## 134 MYKONOS LOUNGE CORNER SET

Mykonos Lounge Corner Set is designed for easy self assembly, it is made of durable weather-resistant resin reinforced with glass fiber. Non-metallic frame will never unravel, rust or decay. It is UV protected which insures the colors will not fade. Can be disassembled. For indoor and outdoor contract use.



White



Silver Grey



Taupe



Mykonos Lounge Corner  
1 pcs

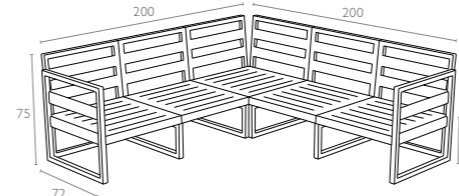

Mykonos Lounge Table  
1 pcs

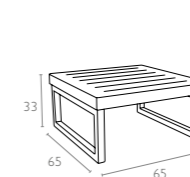

Mykonos Seat Cushion  
5 pcs

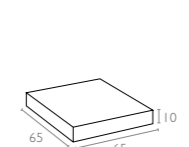

Mykonos Backrest Cushion  
5 pcs

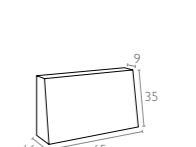

Mykonos Corner Cushion  
1 pcs

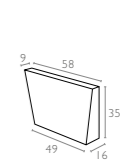

\* Can be purchased with or without cushions.



## 131 MYKONOS LOUNGE ARMCHAIR

Mykonos Lounge Armchair is designed for easy self assembly, it is made of durable weather-resistant resin reinforced with glass fiber. Non-metallic frame will never unravel, rust or decay. It is UV protected which insures the colors will not fade. Can be disassembled.

For indoor and outdoor contract use.

**CATAS**  
TEST REPORT  
282199



White



Taupe



Silver Grey

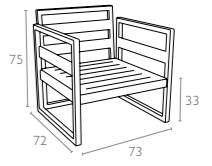

## 137 MYKONOS LOUNGE TABLE

Mykonos Lounge Table is made of durable weather-resistant resin. Non-metallic frame will never unravel, rust or decay. It is UV protected which insures the colors will not fade.

Can be disassembled.

For indoor and outdoor use.



White



Taupe



Silver Grey

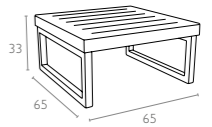

## 138 MYKONOS LOUNGE TABLE XL

Mykonos Lounge Table XL is made of durable weather-resistant resin. Non-metallic frame will never unravel, rust or decay. It is UV protected which insures the colors will not fade.

Can be disassembled.

For indoor and outdoor use.



White



Taupe



Silver Grey

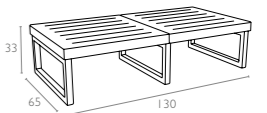

## 136 MYKONOS EXTENSION PART

With the extension part you can add as many seats as you want to extend your corner set.



White



Taupe

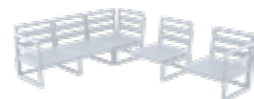

Silver Grey

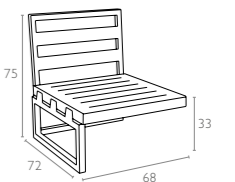

### 087 SLIM

Slim sunlounger is stackable and comes with hidden wheels and anti-slippery rubbers. It is made of durable weather-resistant resin. Non metallic frame will never unravel, rust or decay. It is UV protected which insures the colors will not fade. For outdoor use.



White

Black

Dark Grey

Taupe

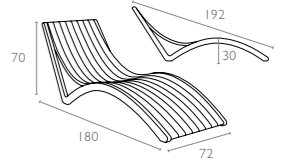

### 089 PACIFIC

Sunlounger without arms, tubular frame in resin reinforced with glass fiber and cover in breathable synthetic fabric (replaceable). Stackable, back reclining in 5 positions, with non-slip feet and small wheels.



White  
White

White  
Taupe

White  
Turquoise

White  
Blue



Dark Grey  
Black

Black  
Black

Taupe  
Taupe

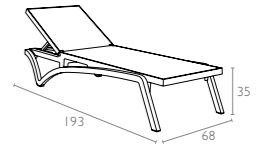

### 262 VICTOR BAR 75

Victor bar stool h.75 cm is produced with a single injection of polypropylene reinforced with glass fiber obtained by means of the latest generation of air moulding technology with neutral tones. For indoor and outdoor use.



White

Dark Grey

Black

Taupe

Olive Green

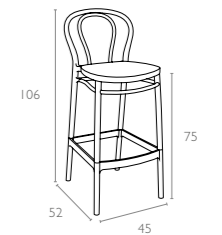

### 261 VICTOR BAR 65

Victor bar stool h.65 cm is produced with a single injection of polypropylene reinforced with glass fibers obtained by means of the latest generation of air moulding technology with neutral tones. For indoor and outdoor use.



White

Dark Grey

Black

Taupe

Olive Green

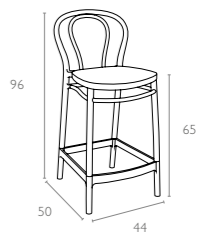

### 266 CROSS BAR 75

Cross bar stool h.75 cm is produced with a single injection of polypropylene reinforced with glass fiber obtained by means of the latest generation of air moulding technology with neutral tones. For indoor and outdoor use.



White



Dark Grey



Black



Taupe



Olive Green

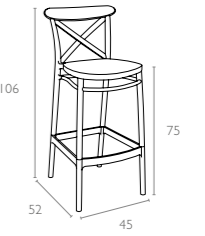

### 264 CROSS BAR 65

Cross bar stool h.65 cm is produced with a single injection of polypropylene reinforced with glass fiber obtained by means of the latest generation of air moulding technology with neutral tones. For indoor and outdoor use.



White



Dark Grey



Black



Taupe



Olive Green

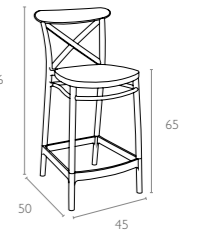

### 269 MARCEL BAR 75

Marcel bar stool h.75 cm is produced with a single injection of polypropylene reinforced with glass fiber obtained by means of the latest generation of air moulding technology with neutral tones. For indoor and outdoor use.



White



Dark Grey



Black



Taupe



Olive Green

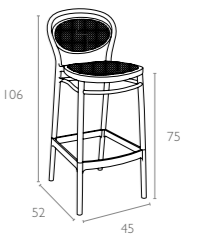

### 268 MARCEL BAR 65

Marcel bar stool h.65 cm is produced with a single injection of polypropylene reinforced with glass fiber obtained by means of the latest generation of air moulding technology with neutral tones. For indoor and outdoor use.



White



Dark Grey



Black



Taupe



Olive Green

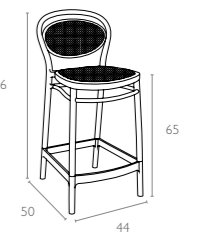



### 099 MAYA BAR 75

Maya stacking bar stool h.75 cm is produced with a single injection of polypropylene reinforced with glass fiber obtained by means of the latest generation of air moulding technology with neutral tones. For indoor and outdoor use.



White



Dark Grey



Black



Taupe



Olive Green

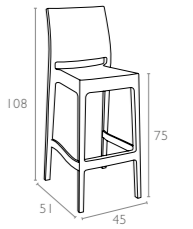

### 100 MAYA BAR 65

Maya stacking bar stool h.65 cm is produced with a single injection of polypropylene reinforced with glass fiber obtained by means of the latest generation of air moulding technology with neutral tones. For indoor and outdoor use.



White



Dark Grey



Black



Taupe



Olive Green

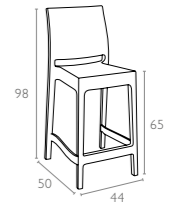

### 101 ARES BAR 75

Ares stacking bar stool h.75 cm is produced with a single injection of polypropylene reinforced with glass fiber obtained by means of the latest generation of air moulding technology with neutral tones. For indoor and outdoor use.



White



Dark Grey



Black



Brown



Taupe

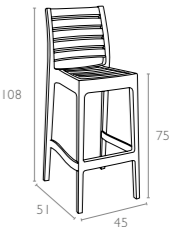

### 073 OPERA BAR 75

Stacking wedding bar stool h.75 cm for indoor and outdoor use in clear or shiny polycarbonate. Scratch resistant, UV - resistant.



Glossy White



Amber Transparent



Clear Transparent

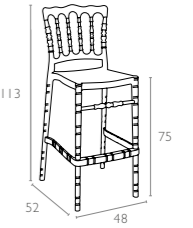

### 074 OPERA BAR 65

Stacking wedding bar stool h.65 cm for indoor and outdoor use in clear or shiny polycarbonate. Scratch resistant, UV - resistant.



Glossy White

Amber Transparent

Clear Transparent

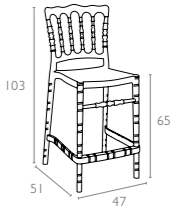
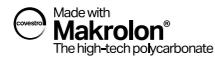

### 083 CHIAVARI BAR 75

Stacking wedding bar stool h.75 cm for indoor and outdoor use in clear or shiny polycarbonate. Scratch resistant, UV - resistant.



Glossy White

Amber Transparent

Clear Transparent

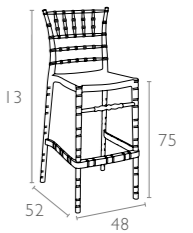
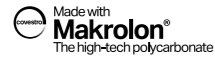

### 084 CHIAVARI BAR 65

Stacking wedding bar stool h.65 cm for indoor and outdoor use in clear or shiny polycarbonate. Scratch resistant, UV - resistant.



Glossy White

Amber Transparent

Clear Transparent

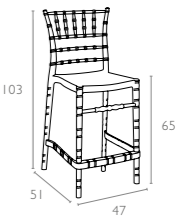
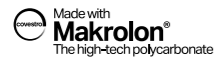

### 037 FOX 75

Stacking bar stool h.75 cm for indoor and outdoor use in shiny technopolymer PA6 nylon or clear polycarbonate. Scratch resistant, self - extinguish classification V2, UV - resistant.



Glossy White

Glossy Red

Clear Transparent

Smoke Grey Transparent

Amber Transparent

Black Transparent

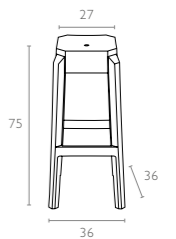

### 036 FOX 65

Stacking bar stool h.65 cm for indoor and outdoor use in shiny technopolymer PA6 nylon or clear polycarbonate. Scratch resistant, self - extinguish classification V2, UV - resistant.



Glossy White

Glossy Red

Clear Transparent

Black Transparent

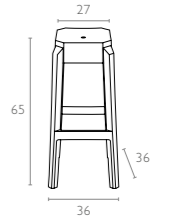
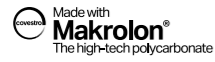

### 068 AIR BAR 75

Air Bar stool h.75 cm is produced with a single injection of polypropylene reinforced with glass fiber obtained by means of the latest generation of air moulding technology with neutral tones. For indoor and outdoor use.



White

Orange

Dark Grey

Black

Taupe

Red

Tropical Green

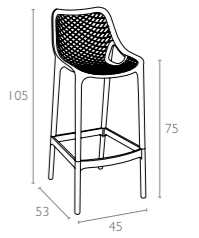

### 067 AIR BAR 65

Air Bar stool h.65 cm is produced with a single injection of polypropylene reinforced with glass fiber obtained by means of the latest generation of air moulding technology with neutral tones. For indoor and outdoor use.



White

Orange

Dark Grey

Black

Taupe

Red

Tropical Green

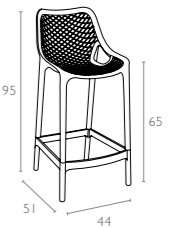

### 042 ARIA

Revolving stool with adjustable height with gas piston. Base and column in stainless steel. Seat in recyclable polycarbonate. For indoor use.



Glossy White

Clear Transparent

Black Transparent

Red Transparent

Amber Transparent

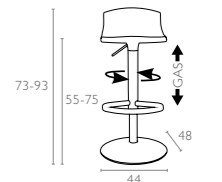
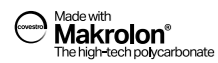

### 035 GIO 75

Stacking bar stool with recyclable polypropylene seat and backrest and square anodized aluminium legs. Diameter 25x25 mm. For indoor and outdoor use.



White



Beige



Red



Orange



Light Green



Black

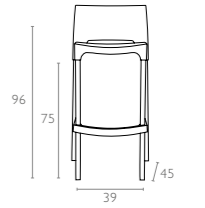

### 065 QUEEN

Stacking side table for indoor and outdoor use in clear polycarbonate. UV - resistant.



Glossy White



Clear Transparent



Black Transparent



Amber Transparent

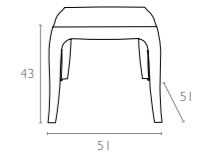

### 109 SKY SIDE TABLE

Sky Side Table is made of durable weather-resistant resin. Non-metallic frame will never unravel, rust or decay. It is UV protected which insures the colors will not fade. Can be disassembled. For indoor and outdoor use.



White



Dark Grey



Black



Taupe



Red



Yellow

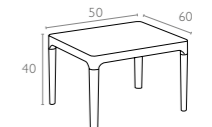

### 104 SKY LOUNGE TABLE

Sky Table is made of durable weather-resistant resin. Metallic frame will never unravel, rust or decay. It is UV protected which insures the colors will not fade. Can be disassembled. For indoor and outdoor use.



White



Dark Grey



Black



Taupe



Red



Yellow

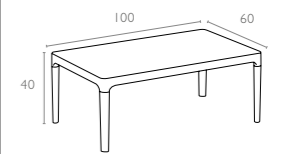

### 064 BOX TABLE

Stacking table in recyclable polypropylene. For indoor and outdoor use.



White Silver Grey Dark Grey Black



Red Orange Tropical Green

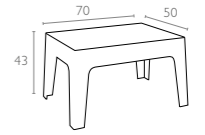

### 066 OCEAN SIDE TABLE

Ocean Side Table is made of durable weather-resistant resin. Non-metallic frame will never unravel, rust or decay. It is UV protected which insures the colors will not fade. Can be disassembled. For indoor and outdoor use.



White



Taupe



Silver Grey



Dark Grey



Black

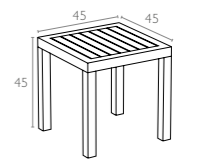

### 069 OCEAN TABLE

Ocean Lounge Table is made of durable weather-resistant resin. Non-metallic frame will never unravel, rust or decay. It is UV protected which insures the colors will not fade. Can be disassembled. For indoor and outdoor use.



White



Taupe



Silver Grey



Dark Grey



Black

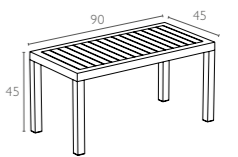

### 772 VEGAS TABLE

Extendible table from 100 to 140 cm in polypropylene reinforced with glass fiber. Easily expandable, giving you a choice of two size options. Smart extending mechanism makes it easy to adjust the table to your preferred size. For indoor and outdoor use with UV protection.

100x100 / 100x140 cm



White



Taupe



Dark Grey



Black

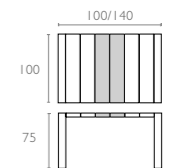

## 774 VEGAS TABLE MEDIUM

Extendible table from 180 to 220 cm in polypropylene reinforced with glass fiber. Easily expandable, giving you a choice of two size options. Smart extending mechanism makes it easy to adjust the table to your preferred size. For indoor and outdoor use with UV protection.

100x180 / 100x220 cm

CATAS  
TEST REPORT  
253098



White



Taupe



Dark Grey



Black

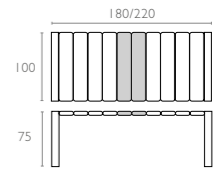

## 776 VEGAS TABLE XL

Extendible table from 260 to 300 cm in polypropylene reinforced with glass fiber. Easily expandable, giving you a choice of two size options. Smart extending mechanism makes it easy to adjust the table to your preferred size. For indoor and outdoor use with UV protection.

100x260 / 100x300 cm

CATAS  
TEST REPORT  
253097



White



Taupe



Dark Grey



Black

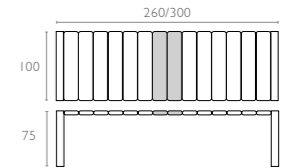

## 114 SKY FOLDING TABLE 60

Sky folding table is made of durable weather-resistant resin. Metallic frame will never unravel, rust or decay. It is UV protected which insures the colors will not fade. Can be disassembled.

For indoor and outdoor use.

60x60 cm



White



Taupe



Dark Grey



Black



Olive Green

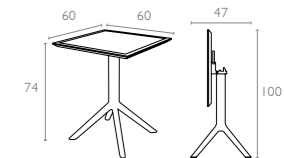

## 108 SKY TABLE 70

Sky Table is made of durable weather-resistant resin. Metallic frame will never unravel, rust or decay. It is UV protected which insures the colors will not fade. Can be disassembled.

For indoor and outdoor use.

70x70 cm



White



Taupe



Dark Grey



Black



Olive Green

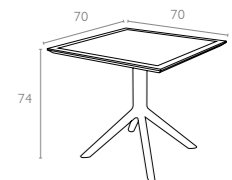

### 106 SKY TABLE 80

Sky Table is made of durable weather-resistant resin. Metallic frame will never unravel, rust or decay. It is UV protected which insures the colors will not fade. Can be disassembled. For indoor and outdoor use.

80x80 cm



White



Taupe



Dark Grey



Black



Olive Green

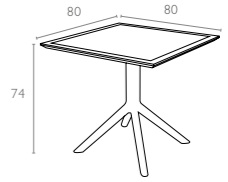

### 700 AIR TABLE 80

Table with plastic legs with HPL compact laminated tops 12 mm available in white and black. For indoor and outdoor use. Can be disassembled.

*\* Dark colors not recommended in direct sunlight.*

80x80 cm



White



Black

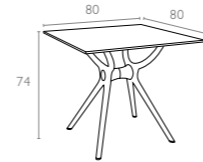

### 335 AIR LEGS SMALL

Air Legs are made up of polypropylene reinforced with glass fiber with the latest generation of air moulding thermoplastic injection. For indoor and outdoor use. Can be disassembled.



White



Black



Taupe

*\* Top min. 70x70 cm, Top max. 90x90 cm*

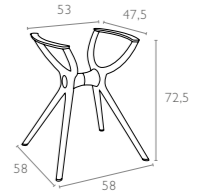

### 705 AIR TABLE 140

Table with plastic legs with HPL compact laminated tops 12 mm available in white and black. For indoor and outdoor use. Can be disassembled.

*\* Dark colors not recommended in direct sunlight.*

80x140 cm



White



Black



### 336 AIR LEGS MEDIUM

Air Legs are made up of polypropylene reinforced with glass fiber with the latest generation of air moulding thermoplastic injection. For indoor and outdoor use. Can be disassembled.



White



Black

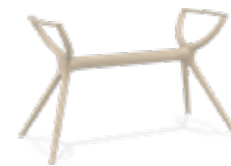

Taupe

*\* Top min. 70x120 cm, Top max. 80x160 cm*

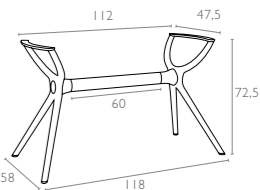

### 715 AIR TABLE 180

Table with plastic legs with HPL compact laminated tops 12 mm available in white and black. For indoor and outdoor use. Can be disassembled.

*\* Dark colors not recommended in direct sunlight.*

90x180 cm



White



Black



### 337 AIR LEGS XL

Air Legs are made up of polypropylene reinforced with glass fiber with the latest generation of air moulding thermoplastic injection. For indoor and outdoor use. Can be disassembled.



White



Black

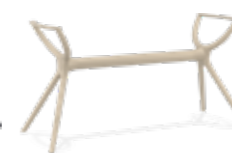

Taupe

*\* Top min 90x180 cm, Top max 100x200 cm*

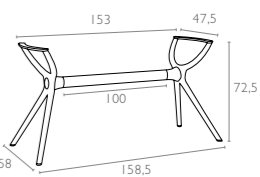

## 118 SKY FOLDING LEGS

Sky folding leg is made of durable weather-resistant resin. Metallic frame will never unravel, rust or decay. It is UV protected which insures the colors will not fade. Can be disassembled and suitable for werzalit or HPL compact tops. For indoor and outdoor use.



White



Black



\* Top min: 50x50 cm Top max: 70x70 cm

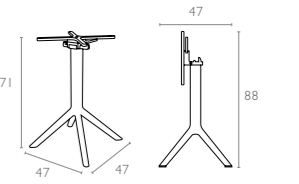

## 107 SKY LEGS

Sky leg is made of durable weather-resistant resin. Metallic frame will never unravel, rust or decay. It is UV protected which insures the colors will not fade. Can be disassembled and suitable for werzalit or HPL compact tops. For indoor and outdoor use.



White



Taupe



Dark Grey



Black

\* Top min: 70x70 cm Top max: 90x90 cm

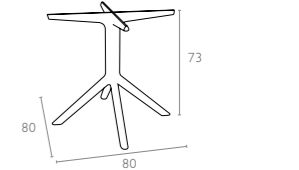

## 160 OCTOPUS 60

Octopus Table is made of durable weather-resistant resin. Metallic frame will never unravel, rust or decay. It is UV protected which insures the colors will not fade. Can be disassembled. For indoor and outdoor use.

Ø 60 cm



White



Taupe



Silver Grey



Dark Grey



Black



Yellow

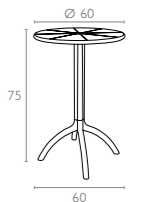

## 161 OCTOPUS BAR

Octopus Bar Table is made of durable weather-resistant resin. Metallic frame will never unravel, rust or decay. It is UV protected which insures the colors will not fade. Can be disassembled. For indoor and outdoor use.

Ø 60 cm



White



Taupe



Dark Grey



Black

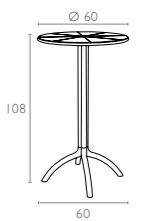



## 116 SKY FOLDING BAR TABLE 60

Sky folding bar table is made of durable weather-resistant resin. Metallic frame will never unravel, rust or decay. It is UV protected which insures the colors will not fade. Can be disassembled. For indoor and outdoor use.  
60x60 cm



White



Taupe



Dark Grey



Black



Olive Green

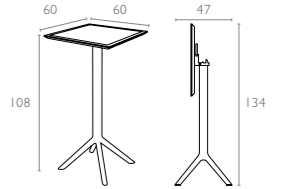

## 164 ARES 80

Ares 80 Table is made of durable weather-resistant resin. Non-metallic frame will never unravel, rust or decay. It is UV protected which insures the colors will not fade. Can be disassembled. For indoor and outdoor use.  
80x80 cm



White



Taupe



Teak



Brown



Dark Grey



Black

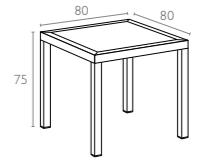

## 186 ARES 140

Ares 140 Table is made of durable weather-resistant resin. Non-metallic frame will never unravel, rust or decay. It is UV protected which insures the colors will not fade. Can be disassembled. For indoor and outdoor use.  
80x140 cm



White



Taupe



Teak



Brown



Dark Grey



Black

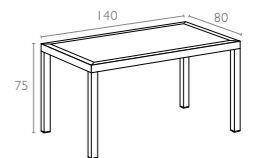

## 685 MAYA 80

HPL compact laminated tops 12 mm with the latest generation of air moulding thermoplastic legs. For indoor and outdoor use. Can be disassembled.

\* Dark colors not recommended in direct sunlight.

80x80 cm



White



Black

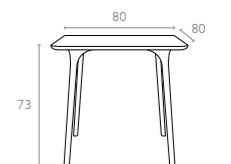

## 675 MAYA 120

HPL compact laminated tops  
12 mm with the latest generation  
of air moulding thermoplastic legs.  
For indoor and outdoor use.  
Can be disassembled.

*\* Dark colors not recommended in direct sunlight.*

Ø 120 cm



White



Black



## 690 MAYA 140

HPL compact laminated tops  
12 mm with the latest generation  
of air moulding thermoplastic legs.  
For indoor and outdoor use.  
Can be disassembled.

*\* Dark colors not recommended in direct sunlight.*

80x140 cm



White



Black

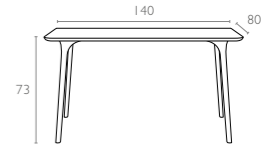

## 500 - 510 - 520 ICE

Table with clear transparent  
polycarbonate leg and painted  
aluminium base. Werzalit tops,  
resistant to outdoor use, available  
in white, black and silver grey.  
For indoor and outdoor use.

Code 500    Ø 60 cm  
Code 510    Ø 70 cm  
Code 520    Ø 80 cm



White



Black



Silver Grey

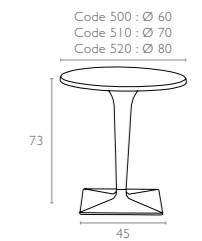

## 550 - 560 ICE

Table with clear transparent  
polycarbonate leg and painted  
aluminium base. Werzalit tops,  
resistant to outdoor use, available  
in white, black and silver grey.  
For indoor and outdoor use.

Code 550    60x60 cm  
Code 560    70x70 cm



White



Black



Silver Grey

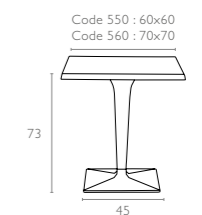

## 310 ICE Leg & Base

Clear transparent polycarbonate leg and painted aluminium base. For indoor and outdoor use.



Clear  
Transparent

Made with  
**Makrolon®**  
The high-tech polycarbonate

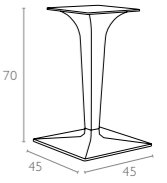

## 800 MANGO

Stacking table with the latest generation of air moulding thermoplastic injection. For indoor and outdoor use.

72x72 cm



White



Beige



Orange



Silver Grey

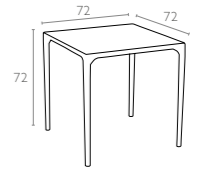

## 758 MANGO ALU

Stacking table with the latest generation of air moulding thermoplastic injection with legs in anodized aluminium. For indoor and outdoor use.

72x72 cm



White



Beige



Orange



Silver Grey

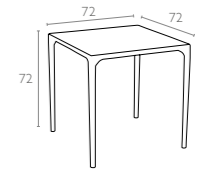

## 770 FORZA

Folding table with legs in anodized aluminium. Diameter 30 mm. Table top in recyclable polypropylene. For indoor and outdoor use.

80x80 cm



White



Beige



Orange



Red



Light Green



Black



Silver Grey



Teak

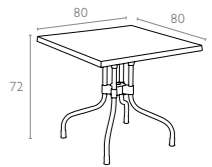

**750 SORTIE**

Table top in recyclable polypropylene, anodized aluminium legs. Diameter 25 mm. For indoor and outdoor use. Can be disassembled.

70x70 cm



White



Beige



Orange



Red



Light Green



Black

**720 POPPY 80**

Table top in recyclable polypropylene, anodized aluminium legs. Diameter 25 mm. For indoor and outdoor use. Can be disassembled.

Ø 80 cm



White

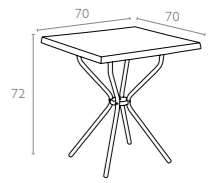

Beige



Orange



Red



Light Green



Black

**710 ELFO 70**

Table top in recyclable polypropylene, anodized aluminium legs. Diameter 25 mm. For indoor and outdoor use. Can be disassembled.

Ø 70 cm



White

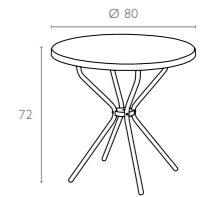

Beige



Orange



Red



Light Green

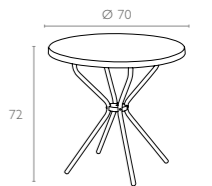

Black

**097 LINK**

Link linking device in polypropylene to be fixed on the frame. Suitable for all round legs Ø 25mm.



Silver Grey

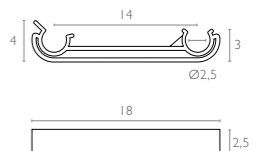

## 415 DODO

Suspension lamp in polycarbonate with 25W energy saving lamp. The diffuser can be removed without dismantling the electrical body, for an easy fitting and removal.



Made with **Makrolon®**  
The high-tech polycarbonate



Clear  
Transparent



Black  
Transparent



Violet  
Transparent



Amber  
Transparent



Pink  
Transparent



Blue  
Transparent



Red  
Transparent



Glossy  
White

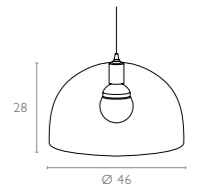

## 410 NOVA

Suspension lamp in polycarbonate with 25W energy saving lamp. The diffuser can be removed without dismantling the electrical body, for an easy fitting and removal.



Made with **Makrolon®**  
The high-tech polycarbonate



Clear  
Transparent



Black  
Transparent



Violet  
Transparent



Amber  
Transparent



Pink  
Transparent



Blue  
Transparent



Red  
Transparent



Glossy  
White

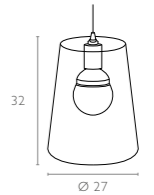

## 420 SMART

Table lamp made of transparent or coloured injected polycarbonate, with 40W lamp. Perfect gift idea.



Made with **Makrolon®**  
The high-tech polycarbonate



Clear  
Transparent



Black  
Transparent



Violet  
Transparent



Amber  
Transparent



Pink  
Transparent



Blue  
Transparent



Red  
Transparent



Glossy  
White

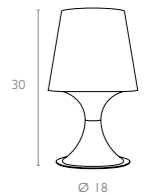

### 899 ARTEMIS XL SEAT CUSHION

5 cm thick seat cushion covered with polyester fabric and finished with piping. Cushion is specially designed for Artemis XL armchair.



White Light Grey Beige

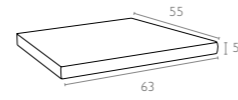

### 900 ARTEMIS XL BACKREST CUSHION

5 cm thick backrest cushion covered with polyester fabric and finished with piping. Cushion is specially designed for Artemis XL armchair.



White Light Grey Beige

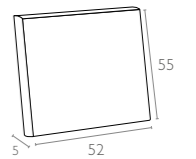

### 141 MYKONOS SEAT CUSHION

10 cm thick cushion covered with Etisilk polyester fabric and finished with piping. Cushions are specially designed for Mykonos Lounge Set. Water resistant with UV.



Beige Light Brown Dark Grey Black

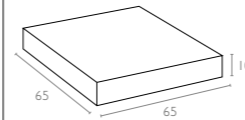

### 142 MYKONOS BACKREST CUSHION

10 cm thick cushion covered with Etisilk polyester fabric and finished with piping. Cushions are specially designed for Mykonos Lounge Set. Water resistant with UV.



Beige Light Brown Dark Grey Black

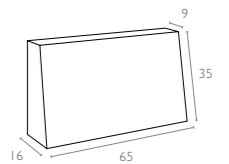

### 143 MYKONOS CORNER CUSHION

10 cm thick cushion covered with Etisilk polyester fabric and finished with piping. Cushions are specially designed for Mykonos Lounge Set. Water resistant with UV.



Beige Light Brown Dark Grey Black

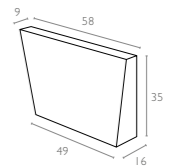

### 144 SLIM CUSHION

3 cm thick cushion covered with Etisilk polyester fabric and finished with piping. Cushions are specially designed for Slim sunlounger. Water resistant with UV.

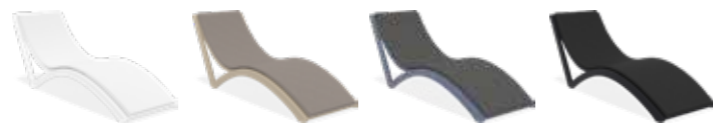

White Light Brown Dark Grey Black

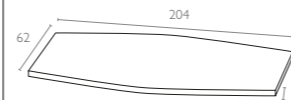

### 148 SLIM PILLOW CUSHION

5 cm thick pillow cushion covered with Etisilk polyester fabric and finished with piping. Cushions are specially designed for Slim sunlounger. Water resistant with UV.

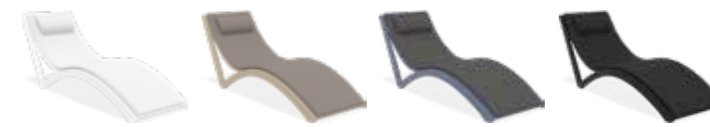

White Light Brown Dark Grey Black

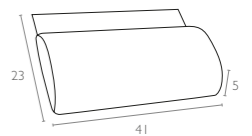

## INFORMATION

Technical dates and pictures in this catalogue are indicative and may not be considered binding; Siesta reserves the right to modify without notice for technical or commercial reasons the products in this catalogue. It is forbidden to re-produce the project or to re-print the catalogue.

All dimensions are in **cm**.

SYMBOLS KEY  
Ø = Diameter  
H = Height

Siesta App available on the App store



Art Direction & Graphic Art  
[www.adkreatik.com](http://www.adkreatik.com)

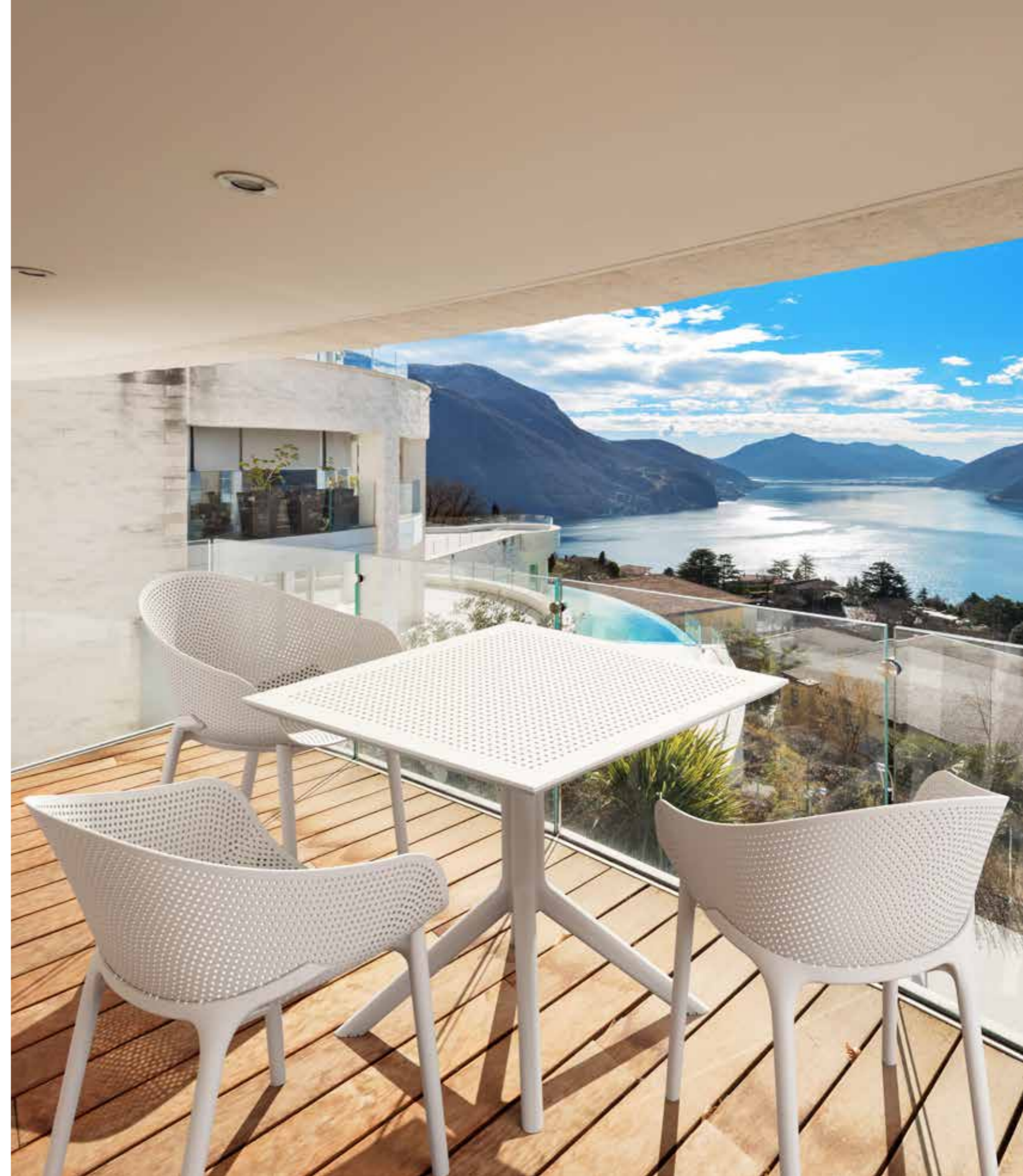

# Siesta exclusive

www.siesta.com.tr



/SiestaFurniture



İŞILPLAST PLASTİK SANAYİ VE TİCARET A.Ş.  
Ulus Mah. Çatalca Yolu Cad. No:597 Tepecik 34537  
Büyükkçekmece - İSTANBUL / TURKEY  
Tel: +90 212 861 50 00  
Fax: +90 212 861 00 24  
export@siesta.com.tr



OFFICIAL PARTNER

